

MK-370EXP TILE SAW

OWNER'S MANUAL, PARTS LIST & OPERATING INSTRUCTIONS



Revision 307	05.2015
Manual Part No. 160084	

Caution: Read all safety and operating instructions before using this equipment. This owners manual **MUST** accompany the equipment at all times.

INTRODUCTION

Congratulations on your purchase of a MK-370EXP Saw Tile Saw. We are certain that you will be pleased with your purchase. MK Diamond takes pride in producing the finest construction power tools and diamond blades in the industry.

Operated correctly, your MK-370EXP Saw should provide you with years of service. In order to help you, we have included this manual. This owners manual contains information necessary to operate and maintain your MK-370EXP Saw safely and correctly. Please take a few minutes to familiarize yourself with the MK-370EXP Saw by reading and reviewing this manual.

If you should have questions concerning your MK-370EXP Saw, please feel free to call our friendly customer service department at: 800 421-5830

Regards,

MK Diamond

NOTE THIS INFORMATION FOR FUTURE USE:

MODEL NUMBER:	
SERIAL NUMBER:	
PURCHASE PLACE:	
PURCHASE DATE:	

NOTE: For your (1) one year warranty to be effective, complete the warranty card (including the Serial Number) and mail it in as soon as possible.

TABLE OF CONTENTS

SAFETY

Safety Messages	4
Damage Prevention Message	4
General Safety Precautions	4-7
California Proposition 65 Message	8
Canadian French Safety Translation	9-14
Electrical Requirements	15-18
Safety Label Locations	20
Product Specifications	21

UNPACKING, TRANSPORT and ASSEMBLY

Unpacking	22
Contents	22
Transport	22

STARTUP, ADJUSTMENT, OPERATION and SHUTDOWN

Cutting Head Installation	23
Diamond Blade Installation	24-25
Adjustable Cutting Guide Installation	25
Splash Guard Installation	25
Water Pump Preparation	25
Pre-Start Inspection	26
Setup for Operation	26-27
Operation	28-33
Cleanup	34-35

MAINTENANCE AND TROUBLESHOOTING

Maintenance	35-39
Troubleshooting	40-47

EXPLODED VIEW AND PARTS LIST

Exploded View & Parts List	48-53
----------------------------	-------

ACCESSORIES ORDERING and RETURN INSTRUCTIONS

Accessories	54
Ordering Information	56
Return Material Policy	56
Packaging Instructions	56
Authorized Service Centers	56
Contact & Warranty	57

Read and follow all safety, operating and maintenance instructions. Failure to read and follow these instructions could result in injury or death to you or others. Failure to read and follow these instructions could also result in damage and/or reduced equipment life. Safety warnings and guidelines do not by themselves eliminate danger. They are not substitutes for proper accident prevention procedures and good judgement.

SAFETY MESSAGES

A safety message alerts you to potential hazards that could hurt you or others. Each safety message is preceded by a safety alert symbol () and one of three words: **DANGER**, **WARNING**, or **CAUTION**.



DANGER You **WILL** be **KILLED** or **SERIOUSLY INJURED** if you **DO NOT** follow directions.



WARNING You **CAN** be **KILLED** or **SERIOUSLY INJURED** if you **DO NOT** follow directions.



CAUTION You **CAN** be **INJURED** if you **DO NOT** follow directions. It may also be used to alert against unsafe practices.

DAMAGE PREVENTION AND INFORMATION MESSAGES

A Damage Prevention Message is to inform the user of important information and/or instructions that could lead to equipment or other property damage if not followed. Information Messages convey information that pertains to the equipment being used. Each message will be preceded by the word **NOTE**, as in the example below.

NOTE: Equipment and/or property damage may result if these instructions are not followed.

GENERAL SAFETY PRECAUTIONS AND HAZARD SYMBOLS

In order to prevent injury, the following safety precautions and symbols should be followed at all times!

SAFETY PRECAUTIONS



ALWAYS read this Owner's Manual before operating the machine. **DO NOT** operate or service this equipment before reading this entire manual. Read and understand all warnings, instructions and controls on the machine. Know how to stop the equipment quickly in case of emergency. It is the operators responsibility to use this machine under safe working conditions and conform with federal, state and local codes or regulations pertaining to safety, air, pollution, noise etc...



ALWAYS keep the Blade and Belt Guards in place. **DO NOT** operate this machine with any guard or safety device removed. A Guard, or any damaged part should be repaired or replaced immediately.



NEVER operate this equipment without proper protective clothing, shatterproof glasses, steel-toed boots and other protective devices required by the job. Non-slip foot wear is recommended.

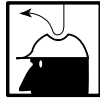

PERSONAL PROTECTIVE EQUIPMENT

ALWAYS wear approved respiratory, head, ear and eye protection when operating this machine.



ACCIDENTAL STARTS!

Before starting the engine/motor, be sure the **ON/OFF** switch is in the **OFF** position to prevent accidental starting. Place the **ON/OFF** switch in the **OFF** position before performing any service operation. **ALWAYS** place the power **ON/OFF** switch in the **OFF** position when the saw is not in use.



ROTATING PARTS

Keep hands, feet, hair, and clothing away from all moving parts to prevent injury. Never operate the motor with covers, shrouds, or guards, removed.



HOT PARTS!

Engine components can become extremely hot from operation. To prevent severe burns, do not touch these areas while the engine is running, or immediately after it is turned off. Never operate the engine with heat shields removed.



OVER SPEED

NEVER tamper with the governor components or settings to increase the maximum speed. Severe personal injury and damage to the engine or equipment can result if operated at speeds above maximum.



ELECTRICAL SHOCK

NEVER touch electrical wires or components while the engine is running. Exposed, frayed or worn electrical wiring and plugs can be sources of electrical shock which could cause severe injury or burns. Do not touch the plug with wet hands.



ALWAYS avoid inhalation of and skin contact with silica dust and/or mist. Provide proper dust removal. Use dust-collection system when applicable.



NEVER operate the machine in an explosive atmosphere or near combustible materials. Sparks from the cutting-action of this machine can ignite flammable materials, liquids, gases or dust.



This equipment should not be operated by persons under 18 years of age.



KEEP CHILDREN AWAY

All visitors and children should be kept a safe distance from work area. Maintain a safe operating distance to other personnel.



MAKE THE WORKSHOP KID PROOF

Make the workshops kid proof by using padlocks, master switches or by removing starter keys.



DO NOT FORCE THE TOOL

A power tool will do a job better and safer operating at the rate for which it was designed. **DO NOT** force a tool or an attachment to do a job that it was not designed to do.

**USE PROPER APPAREL**

DO NOT wear loose clothing, gloves, neckties, rings, bracelets, or other jewelry that may be caught in moving parts. Non-slip footwear is recommended. Wear protective hair covering to contain long hair.

**SECURE WORK**

Clamps or a vise should be used to hold work whenever practical. Keeping your hands free to operate a power tool is safer.

**DO NOT OVERREACH**

Keep proper footing and balance at all times by not overreaching.

**DISCONNECT TOOLS**

Power tools should always be disconnected before servicing, adjusting or when changing accessories, such as blades, bits, cutters, and the like.

**MAINTAIN TOOLS WITH CARE**

Keep tools clean and maintained for the best and safest performance. Always follow maintenance instructions and examine the machine before use. If any abnormal vibrations or noises occurs, turn off machine immediately and have the problem corrected before further use.

**REMOVE ADJUSTING KEYS AND WRENCHES**

Form a habit of checking to see that keys and adjusting wrenches are removed from the power tool before it is turned on.

**KEEP WORK AREA CLEAN**

Cluttered work areas and benches invite accidents. Keep area around machine clear of obstructions which could cause persons to fall.

**DO NOT USE IN DANGEROUS PLACES**

DO NOT operate equipment in dangerous or hazardous environments. **DO NOT** use power tools in damp or wet locations nor expose them to rain. Always keep the work area well lighted.

**USE RECOMMENDED ACCESSORIES**

Consult the owner's manual for recommended accessories. Using improper accessories may increase the risk of personal or by-stander injury. Unauthorized equipment modifications will void all warranties. Manufacturer does not assume responsibility for any accident due to equipment modifications.



ALWAYS ensure that the machine is on level ground before using.

**NEVER STAND ON THE TOOL**

Serious injury could occur if a power tool is tipped, or if a cutting tool is unintentionally contacted.

**TRANSPORT**

When loading or unloading the machine, use caution. Remove the blade prior to hoisting, loading and transporting the machine.

**CHECK FOR DAMAGED PARTS**

Before using a power tool, check for damaged parts. A guard or any other part that is damaged should be carefully checked to determine if it would operate properly and perform its intended function. Always check moving parts for proper alignment or binding. Check for broken parts and mountings and all other conditions that may affect the operation of the power tool. A guard, or any damaged part, should be properly repaired or replaced. Always check the machine for loose bolts before starting.

**DIRECTION OF ROTATION**

A blade or cutter should always be installed so that rotation is in the direction of the arrow imprinted on the side of the blade or cutter. It should correspond with the rotational direction of the motor. Always feed work into a blade against the direction of rotation.

**NEVER LEAVE A TOOL UNATTENDED**

TURN POWER OFF - Do not leave a tool until it comes to a complete stop. **ALWAYS** turn a power tool **OFF** when leaving the work area, or, when a cut is finished.



NEVER disconnect any "emergency or safety devices". These devices are intended for operator safety. Disconnection of these devices can cause severe injury, bodily harm, or even death! Disconnection of any of these devices will void all warranties. Unauthorized equipment modifications will void all warranties. Manufacturer does not assume responsibility for any accident due to equipment modifications.



NEVER use this machine with any cutter designed for woodworking.



NEVER operate this equipment when not feeling well due to fatigue, illness or taking medicine.



NEVER operate this equipment under the influence of drugs or alcohol.



On belt driven equipment, overtensioning of belts will result in premature crank and/or bearing failure.



Whenever necessary, replace nameplate, operation and safety decals when they become difficult to read.



ALWAYS store equipment properly when it is not being used. Equipment should be stored in a clean, dry location out of the reach of children



DO NOT lend or rent this equipment without including the Owner's Manual and the Engine/Motor Manufacturer's Manual.



Check the chemical properties of the material to be cut/grinded and follow all EPA/OSHA Regulations.

SILICA DUST WARNING

Grinding/cutting/drilling of masonry, concrete, metal and other materials with silica in their composition may give off dust or mists containing crystalline silica. Silica is a basic component of sand, quartz, brick clay, granite and numerous other minerals and rocks. Repeated and/or substantial inhalation of airborne crystalline silica can cause serious or fatal respiratory diseases, including silicosis. In addition, California and some other authorities have listed respirable crystalline silica as a substance known to cause cancer. When cutting such materials, always follow respiratory precautions.

Use appropriate NIOSH-approved respiratory protection where dust hazard may occur. Paper masks or surgical masks without a NIOSH approval number are not recommended because they do little to protect the worker. For more information about respirator programs, including what respirators have received NIOSH approval as safe and effective, please visit the NIOSH website at:
<http://www.cdc.gov/niosh/topics/respirators>

Observe OSHA regulations for respirator use (29 C.F.R. §1910.134).
Visit <http://www.osha.gov> for more information.

CALIFORNIA PROPOSITION 65 MESSAGE

Some dust created by power sanding, sawing, grinding, drilling, and other construction activities contain chemicals known (to the State of California) to cause cancer, birth defects or other reproductive harm. Some examples of these chemicals are:

- Lead, from lead-based paints
- Crystalline silica from bricks, cement and other masonry products
- Arsenic and chromium, from chemically treated lumber

For further information, consult the following sources:
<http://www.osha.gov/dsg/topics/silicacrystalline/index.html>
<http://www.cdc.gov/niosh/docs/96-112/>
<http://oehha.ca.gov/prop65/law/P65law72003.html>
<http://www.dir.ca.gov/Title8/sub4.html>

Your risk from these exposures varies depending on how often you do this type of work. To reduce your exposure to these chemicals, work in a well-ventilated area, and work with approved safety equipment, such as dust masks that are specially designed to filter out microscopic particles. Where use of a dust extraction device is possible, it should be used. To achieve a high level of dust collection, use an industrial vacuum cleaner.



WARNING

Sawing and drilling generate dust. Excessive airborne particles may cause irritation to eyes, skin and respiratory tract. To avoid breathing impairment, always employ dust controls and protection suitable to the material being sawed or drilled; See OSHA (29 CFR Part 1910.1200).

Lisez et suivez toutes les consignes de sécurité, d'utilisation et d'entretien. Ne pas lire et suivre ces consignes pourrait entraîner des blessures, voire la mort, pour vous ou d'autres personnes. Ne pas lire et suivre ces consignes pourrait aussi endommager et/ou raccourcir la durée de vie de l'équipement. Les avertissements et les directives de sécurité n'éliminent pas, par eux-mêmes, les risques. Ils ne remplacent pas les mesures efficaces de prévention des accidents et le bon jugement.

MESSAGES DE SÉCURITÉ

Un message de sécurité vous signale les dangers potentiels pour vous ou d'autres personnes. Chaque message de sécurité est précédé par un symbole d'alerte de sécurité () et par l'un des trois mots suivants : **DANGER**, **AVERTISSEMENT** ou **ATTENTION**.



DANGER

LE NON-RESPECT des consignes **entraînera** des **BLESSURES GRAVES** voire la **MORT**.



AVERTISSEMENT

LE NON-RESPECT des consignes **PEUT ENTRAÎNER** des **BLESSURES GRAVES** voire la **MORT**.



ATTENTION

LE NON-RESPECT des consignes **PEUT ENTRAÎNER** des **BLESSURES**. Il peut également être utilisé pour alerter contre les pratiques dangereuses.

PREVENTION DES DOMMAGES ET MESSAGES D'INFORMATION

Un message de prévention des dommages doit informer l'utilisateur des informations et/ou consignes importantes, qui, si elles ne sont pas suivies, pourraient endommager l'équipement ou conduire à d'autres dommages matériels. Les messages d'information transmettent des informations relatives à l'équipement utilisé. Chaque message sera précédé par le mot **REMARQUE**, comme dans l'exemple ci-dessous.

REMARQUE : Des dommages à l'équipement et/ou des dommages matériels peuvent survenir si les instructions ne sont pas suivies.

CONSIGNES DE SÉCURITÉ GÉNÉRALES ET SYMBOLES DE DANGER

Afin de prévenir les blessures, les consignes et les symboles de sécurité suivants doivent être respectés en tout temps!



TOUJOURS lire ce manuel avant d'utiliser l'outil. **NE PAS** utiliser ou entretenir cet équipement avant d'avoir lu ce manuel en entier. Lire et comprendre tous les avertissements, instructions et commandes de l'outil. Savoir comment arrêter rapidement l'équipement en cas d'urgence. Il est de la responsabilité de l'opérateur d'utiliser cet outil dans des conditions de travail sûres et conformes aux codes et règlements fédéraux, provinciaux et locaux relatifs à la sécurité, l'air, la pollution, le bruit, etc.



TOUJOURS garder les protections de la lame et de la courroie en place. **NE PAS** utiliser cet outil en l'absence d'un dispositif de protection ou de sécurité. Une protection ou toute pièce endommagée doit être réparée ou remplacée immédiatement.



NE JAMAIS utiliser cet équipement sans vêtements de protection appropriés, lunettes incassables, bottes à embout d'acier et autres dispositifs de protection requis par la tâche. Il est conseillé d'utiliser des chaussures antidérapantes.

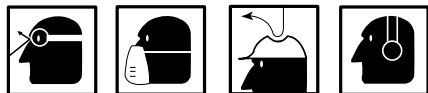

ÉQUIPEMENT DE PROTECTION INDIVIDUELLE

Portez **TOUJOURS** l'équipement de protection respiratoire, auriculaire et oculaire homologué lors de l'utilisation de cet outil.



DÉMARRAGES ACCIDENTELS!

Avant de démarrer le moteur, vérifiez que le commutateur **MARCHE-ARRÊT** est en position **ARRÊT** (OFF) pour empêcher tout démarrage accidentel. Placez le commutateur **MARCHE-ARRÊT** en position **ARRÊT** (OFF) avant toute intervention d'entretien. Placez **TOUJOURS** le commutateur **MARCHE-ARRÊT** en position **ARRÊT** (OFF) lorsque vous n'utilisez pas l'outil.



PIÈCES TOURNANTES

Éloigner les mains, les pieds, les cheveux et les vêtements des pièces mobiles pour éviter des blessures. Ne jamais utiliser le moteur si le couvercle, l'enveloppe de protection ou les protecteurs ont été retirés.



PIÈCES CHAUDES!

Les composants du moteur peuvent devenir très chauds pendant le fonctionnement. Pour éviter des brûlures graves, ne pas toucher ces zones pendant que le moteur tourne ou immédiatement après l'avoir arrêté. Ne jamais faire fonctionner le moteur sans les écrans de chaleur.



SURVITESSE

NE JAMAIS modifier les composants ou réglages du limiteur de régime afin d'augmenter la vitesse maximale. De graves blessures et des dommages au moteur ou à l'équipement peuvent en résulter s'il fonctionne à des vitesses supérieures au maximum.



DÉCHARGE ÉLECTRIQUE

NE JAMAIS toucher les fils ou les composants électriques pendant que le moteur est en marche. Les câbles et fiches nus, effilochés ou usés peuvent être des sources de choc électrique qui pourraient provoquer de graves blessures ou brûlures. Ne pas toucher la fiche avec des mains humides.



TOUJOURS éviter l'inhalation et le contact de la peau avec la poussière et/ou un nuage de silice. Prévoir un système de dépoussiérage adéquat. Utiliser un système de captage des poussières, le cas échéant.



NE JAMAIS utiliser l'outil dans une atmosphère explosive ou près de matériaux combustibles. Les étincelles produites par l'action de coupe de cet outil peuvent enflammer les matériaux, les liquides, les gaz ou les poussières inflammables.



Cet équipement ne doit pas être utilisé par des personnes de moins de 18 ans.



GARDER LES ENFANTS À L'ÉCART

Tous les visiteurs et les enfants doivent se tenir à bonne distance de la zone de travail. Maintenir une distance d'utilisation sécuritaire par rapport aux autres membres du personnel.



RENDRE L'ATELIER SÛR POUR LES ENFANTS

Rentre les ateliers sûrs pour les enfants à l'aide de cadenas, d'interrupteurs principaux ou en retirant les clés de démarrage.



NE PAS FORCER L'OUTIL

Un outil électrique exécutera la tâche mieux et de manière plus sûre s'il est utilisé dans les limites prévues. **NE PAS** forcer un outil ou un accessoire à exécuter une tâche pour laquelle il n'est pas conçu.

**UTILISER DES VÊTEMENTS APPROPRIÉS**

NE PAS porter de vêtements amples, gants, cravates, bagues, bracelets ou autres bijoux susceptibles de se prendre dans les pièces mobiles. Le port de chaussures antidérapantes est recommandé. Les cheveux longs doivent être ramassés sous un couvre-chef.

**FIXER LES PIÈCES DE TRAVAIL**

Dans la mesure du possible, utiliser des serre-joints ou un étau pour maintenir la pièce de travail. Il est plus sûr de garder les mains libres pour manœuvrer un outil électrique.

**NE PAS TRAVAILLER HORS DE PORTÉE**

Toujours se tenir bien campé et avoir un bon équilibre en ne travaillant pas hors de portée.

**DÉBRANCHER LES OUTILS**

Les outils électriques doivent toujours être débranchés avant l'entretien, le réglage ou le remplacement des accessoires, tels que lames, fraises et autres.

**ENTREtenir SOIGNEUSEMENT LES OUTILS**

Garder les outils propres et bien entretenus pour une performance optimale et sécuritaire. Toujours suivre les instructions d'entretien et examiner l'outil avant utilisation. Si des vibrations ou des bruits anormaux se produisent, éteindre immédiatement l'outil et faire corriger le problème avant toute nouvelle utilisation.

**RETIRER LES CLÉS ET OUTILS DE RÉGLAGE**

Prendre l'habitude de vérifier que tous les outils et les clés de réglage ont été retirés de l'outil électrique avant de le mettre en marche.

**GARDER LE LIEU DE TRAVAIL PROPRE**

Un lieu de travail ou un établi encombré est propice aux accidents. Garder la zone autour de la machine dégagée de tout obstacle qui pourrait faire tomber quelqu'un.

**NE PAS UTILISER DANS DES ENDROITS DANGEREUX**

NE PAS utiliser l'équipement dans des environnements dangereux. **NE PAS** utiliser les outils électriques dans des endroits mouillés ou humides, ne pas les exposer à la pluie. Toujours garder le lieu de travail bien éclairé.

**UTILISER LES ACCESSOIRES RECOMMANDÉS**

Voir les accessoires recommandés dans le manuel d'utilisation. L'utilisation d'accessoires inadéquats peut augmenter le risque de blessure du personnel ou des passants. Les modifications non autorisées de l'équipement annuleront toutes les garanties. Le fabricant décline toute responsabilité pour tout accident dû à une modification de l'équipement.



TOUJOURS s'assurer que la machine est sur un terrain plat avant de l'utiliser.

**NE JAMAIS SE TENIR DEBOUT SUR L'OUTIL**

Le basculement de l'outil électrique ou un contact accidentel avec l'accessoire de coupe peut causer des blessures graves.

**TRANSPORT**

Faire preuve de prudence lors du chargement ou déchargement de l'outil. Retirer la lame avant le levage, le chargement et le transport de l'outil.

**VÉRIFICATION DES PIÈCES ENDOMMAGÉES**

Avant d'utiliser un outil électrique, vérifier s'il y a des pièces endommagées. Examiner soigneusement les pièces et dispositifs de protection qui semblent endommagés afin de déterminer s'ils fonctionnent correctement et remplissent les fonctions prévues. Vérifier toujours l'alignement et le réglage corrects des pièces mobiles. Vérifier s'il y a des pièces ou des supports cassés et toutes autres conditions qui peuvent affecter le fonctionnement de l'outil électrique. Une protection ou toute pièce endommagée doit être correctement réparée ou remplacée. Vérifier toujours l'outil pour d'éventuels boulons desserrés avant de le démarrer.

**SENS DE ROTATION**

Une lame ou un outil tranchant doit toujours être installé de telle sorte que la rotation s'effectue dans le sens de la flèche imprimée sur le côté de la lame ou de l'outil tranchant. Elle doit correspondre au sens de rotation du moteur. Toujours alimenter le matériau à couper vers une lame contre le sens de la rotation.

**NE JAMAIS LAISSER UN OUTIL SANS SURVEILLANCE**

COUPER LE COURANT - Ne pas s'éloigner de l'outil avant qu'il soit parvenu à un arrêt complet. **TOUJOURS** mettre l'outil électrique **hors tension** au moment de quitter la zone de travail, ou, lorsqu'une coupe est terminée.



NE JAMAIS débrancher tous les « dispositifs d'urgence ou de sécurité ». Ces dispositifs sont prévus pour la sécurité de l'opérateur. La déconnexion de ces dispositifs peut causer des blessures graves, des lésions corporelles, voire la mort! La déconnexion d'un de ces dispositifs annulera toutes les garanties. Les modifications non autorisées de l'équipement annuleront toutes les garanties. Le fabricant décline toute responsabilité pour tout accident dû à une modification de l'équipement.



NE JAMAIS utiliser cette machine avec un outil de coupe conçu pour le travail du bois.



NE JAMAIS utiliser cet équipement lorsqu'on ne se sent pas bien en raison de la fatigue, une maladie ou des médicaments.



NE JAMAIS utiliser cet équipement sous l'influence de l'alcool ou de drogues.



Sur les équipements actionnés par courroie, tendre excessivement les courroies peut entraîner une usure prématurée du vilebrequin et/ou des roulements.



Chaque fois que nécessaire, remplacer la plaque signalétique ainsi que les autocollants d'utilisation et de sécurité quand ils deviennent difficiles à lire.



TOUJOURS ranger l'équipement correctement lorsqu'il n'est pas utilisé. L'équipement doit être rangé dans un endroit propre et sec, hors de portée des enfants.



NE PAS prêter ou louer cet équipement sans inclure le manuel d'utilisation et le manuel du fabricant du moteur.



Vérifier les propriétés chimiques de la matière à découper/rectifier et respecter toutes les réglementations EPA/OSHA.

AVERTISSEMENT SUR LA POUSSIÈRE DE SILICE

La rectification/la coupe/le perçage de la maçonnerie, du béton, du métal et d'autres matériaux contenant de la silice dans leur composition peut dégager de la poussière ou des nuages contenant de la silice cristalline. La silice est un composant de base du sable, du quartz, de la brique d'argile, du granit et de nombreux autres minéraux et roches. L'inhalation répétée et/ou substantielle de silice cristalline aéroportée peut causer des maladies respiratoires graves, voire mortelles, y compris la silicose. En outre, la Californie et d'autres autorités ont classé la silice cristalline respirable comme une substance connue pour causer le cancer. Lors de la découpe de tels matériaux, suivez toujours les précautions respiratoires.

Utiliser une protection respiratoire appropriée et approuvée NIOSH lorsqu'il existe un risque de poussière. Les masques en papier ou les masques chirurgicaux sans numéro d'homologation NIOSH ne sont pas recommandés, parce qu'ils ne protègent pas suffisamment le travailleur. Pour plus d'informations sur les programmes respiratoires, y compris quels appareils respiratoires ont reçu l'homologation NIOSH attestant qu'ils sont sûrs et efficaces, veuillez visiter le site Web NIOSH à l'adresse :
<http://www.cdc.gov/niosh/topics/respirators>

Respecter les réglementations de l'OSHA relatives à l'utilisation d'un appareil respiratoire (29 C.F.R.§1910.134). Visitez le site *<http://www.osha.gov>* pour obtenir de plus amples renseignements.

SÉCURITÉ DU MOTEUR ÉLECTRIQUE

Pour les soins et les interventions d'entretien du moteur électrique, reportez-vous au livret d'instructions de votre moteur électrique fourni avec le moteur électrique. Protéger le moteur électrique contre la poussière autant que possible et garder les ouvertures de ventilation propres. Avant de brancher l'outil, s'assurer que la tension de sortie est dans la plage indiquée sur la plaque signalétique de l'outil.



ATTENTION



NE PAS pulvériser de l'eau sur le moteur électrique. **NE PAS** toucher la fiche avec des mains humides. Pour réduire le risque d'électrocution, garder toutes les connexions au sec et au-dessus du sol.



NE PAS faire fonctionner le moteur électrique dans un environnement explosif.



NE PAS EXPOSER À LA PLUIE
NE PAS exposer à la pluie ou l'humidité.



AVERTISSEMENT



Si l'utilisation de l'équipement dans des endroits humides est inévitable, utiliser **TOUJOURS** un disjoncteur différentiel, porter **TOUJOURS** des gants et des chaussures en caoutchouc dans les conditions humides.



NE PAS maltraiter le cordon d'alimentation. Ne jamais utiliser le cordon d'alimentation pour transporter l'équipement et ne jamais débrancher ce dernier en tirant sur le cordon. Garder le cordon éloigné de la chaleur, des arêtes vives et des pièces mobiles. Remplacer immédiatement tout cordon endommagé. Un cordon endommagé accroît le risque de choc électrique.



AVERTISSEMENT

Pour réduire le risque d'électrocution, garder toutes les connexions au sec et au-dessus du sol. Les circuits et prises sur lesquels cet outil est branché doivent être protégés par un disjoncteur différentiel (GFCI). Des prises avec un disjoncteur différentiel intégré sont disponibles et peuvent être utilisées pour satisfaire à cette mesure de sécurité. Lors de l'utilisation d'une rallonge, le disjoncteur différentiel doit être installé au plus près de la source d'alimentation, suivi par la rallonge puis enfin, par l'outil.



AVERTISSEMENT

La pompe à eau nécessite un disjoncteur différentiel. Pour réduire le risque de décharge électrique lors de l'utilisation de l'outil avec la pompe branchée dans la prise à 3 pôles sur le moteur, connecter l'appareil à une prise GFCI. Consulter le manuel de la pompe et les balises d'information jointes séparément pour toute information sur la pompe.

ELECTRIC MOTOR SAFETY

For maintenance care and operation of the electric motor, refer to your electric motor instruction booklet furnished with the electric motor. Protect the electric motor from dust as much as possible and keep ventilating openings clean. Before plugging in the machine, make sure that the outlet voltage is within the voltage marked on the machines's data plate.



CAUTION



DO NOT spray water on the electric motor. **DO NOT** touch the plug with wet hands. To reduce the risk of electrocution, keep all connections dry and off the ground.



DO NOT operate electric motor in an explosive environment.



DO NOT EXPOSE TO RAIN

DO NOT expose to rain or use in damp locations.



WARNING



If operating the equipment in damp locations is unavoidable, **ALWAYS** use a Ground Fault Circuit Interrupter, **ALWAYS** wear rubber gloves and footwear in damp conditions.



DO NOT abuse the cord. Never use the cord to carry the equipment or to pull the plug from the outlet. Keep the cord away from heat, sharp edges, and moving parts. Replace damaged cords immediately. Damaged cords increase the risk of electric shock.



WARNING

To reduce the risk of electrocution, keep all connections dry and off the ground. A Ground Fault Circuit Interrupter (GFCI) should be provided on the circuit(s) or outlet(s) to be used for this machine. Receptacles are available having built-in GFCI protections and may be used for this measure of safety. When using an extension cord, GFCI should be installed closest to the power source, followed by the extension cord and lastly, the machine.



WARNING

The water pump requires a GFCI. To reduce risk of electrical shock when operating the machine with the pump plugged into the 3-pole receptacle on the motor, connect the saw to a GFCI outlet. See the pump manual and informational tags enclosed separately for all pump information.

ELECTRICAL REQUIREMENTS AND GROUNDING INSTRUCTIONS

In order to prevent electrical shock and injury, the following electrical safety precautions and symbols should be followed at all times!

WARNING

In case of a malfunction or breakdown, grounding provides a path of least resistance for electrical current to reduce the risk of electric shock. This tool is equipped with an electric cord which has an equipment-grounding conductor and a grounding plug. The plug must be plugged into a matching outlet that is properly installed and grounded in accordance with all local codes and ordinances.

- **DO NOT** modify the plug provided - if it will not fit the outlet, have the proper outlet installed by a qualified electrician.
- Improper connections of the equipment-grounding conductor can result in a risk of electric shock. The equipment-grounding conductor is the insulated conductor that has an outer surface that is green, with or without yellow stripes. If repair or replacement of the electric cord or plug is necessary, **DO NOT** connect the equipment-grounding conductor to a live terminal.
- Check with a qualified electrician or service personnel if the grounding instructions are not completely understood, or if in doubt as to whether the tool is properly grounded.
- Use only 3-wire extension cords that have 3-prong grounding plugs and 3-pole receptacles that accept the tool's plug.
- Repair or replace a damaged or worn cord immediately.

This tool is intended for use on a circuit that has an outlet that looks like the one shown in Sketch A. The tool has a grounding plug that looks like the plug illustrated in Sketch A. A temporary adapter, which looks like the adapter illustrated in sketches B and C, may be used to connect this plug to a 2-pole receptacle as shown in Sketch B, if a properly grounded outlet is not available. The temporary adapter should be used only until a properly grounded outlet can be installed by a qualified electrician. The green-colored rigid ear, plug, and the like, extending from the adapter, must be connected to a permanent ground, such as a properly grounded outlet box.

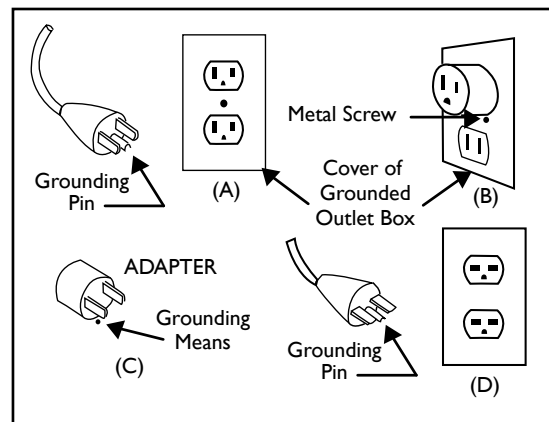

Circuit and Adapter Information

NOTE: Use of a temporary adapter is not permitted in Canada.

NOTE: If permanently connected this tool should be connected to a grounded metal permanent wiring system; or to a system having an equipment - grounding conductor.

**WARNING**

To avoid the possibility of the appliance or plug receptacle getting wet, position the machine to one side of a wall mounted receptacle. This will prevent water from dripping into the receptacle or plug. A "drip loop," shown in the picture below, should be arranged by the user to properly position the power cord relative to the power source. Use the drip loop as a way to prevent GFCI and plug from getting wet.

The "drip loop" is that part of the cord below the level of the receptacle (or the connector, if an extension cord is used). This method of positioning the cord prevents the travel of water along the power cord and coming in contact with the receptacle.

If the plug or receptacle gets wet, **DO NOT** unplug the cord. Disconnect the fuse or circuit breaker that supplies power to the tool. Then unplug and examine for presence of water in the receptacle.

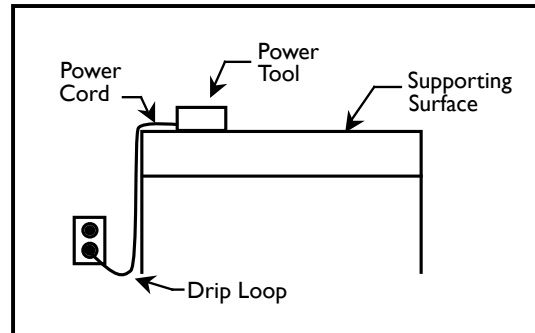

Drip Loop Information

**WARNING**

Use only extension cords that are intended for outdoor use. These extension cords are identified by a marking "Acceptable for use with outdoor appliances; store indoors while not in use." Use only extension cords having an electrical rating not less than the rating of the product. **DO NOT** use damaged extension cords. Examine extension cords before using and replace if damaged. **DO NOT** abuse extension cords and **DO NOT** yank on any cord to disconnect. Keep cords away from heat and sharp edges. Always disconnect the extension cord from the receptacle before disconnecting the product from the extension cord.

ALWAYS make certain that the power source required for the electric motor is correct and always use the correct NEMA configuration plug. Motors can burn out when the line voltage falls 10% below the voltage rating of the motor. Failure to use proper voltage will cause the motor to overheat. Make certain that the correct size grounded (3-wires) extension cord is used.

**WARNING**

Use of undersized extension cords result in low voltage to the motor that can result in motor burnout and premature failure. MK Diamond warns that equipment returned to us showing signs of being run in a low voltage condition, through the use of undersized extension cords, will be repaired or replaced totally at the customer's expense. There will be no warranty claim.

To choose the proper extension cord,

- Locate the length of extension cord needed in the table below.
- Once the proper length is found, move down the column to obtain the correct AWG size required for that length of extension cord.

MOTOR SPECS			EXTENSION CORD LENGTH			
Motor	Voltage	Amps	25'	50'	100'	200'
156428-R	120V 1 Ph	7.4	16 ga	14 ga	10 ga	8 ga

SAFETY LABEL LOCATIONS

Safety labels contain important safety information. Please read the information contained on each safety label. These labels are considered a permanent part of your saw. If a label comes off or becomes hard to read, contact MK Diamond or your dealer for a replacement.



Part # 164202

A

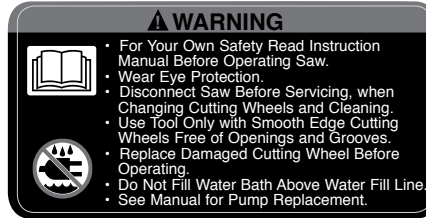

Part # 155806

B

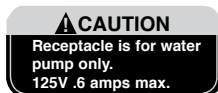

Part # 154822

C



Part # 155678

D



Part # 155038

E

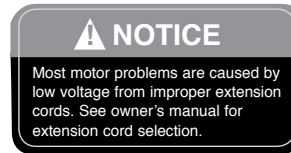

Part # 155672

F



Part # 170480

G

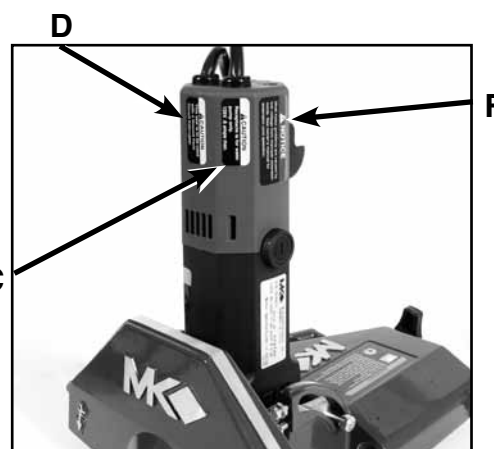
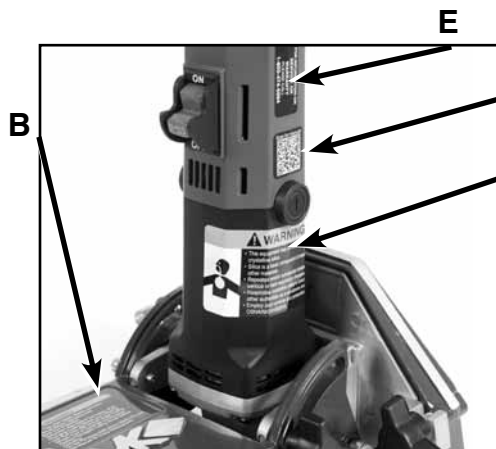

Decal/Label	Location	Description
A	Motor - Front	Warning - Silica Warning
B	Cutting Head	Warning - Read and Follow Operating Instructions
C	Motor - Side	Caution - Receptacle for Water Pump
D	Motor - Side	Caution - Use with GFCI only
E	Motor - Front	Service/ Warranty
F	Motor - Back	Notice - Voltage/extension cords
G	Motor - Front	QR Codes for Manuals

PRODUCT SPECIFICATIONS

The MK-370EXP Saw is a versatile Tile Saw. Operated and used according to this manual, the MK-370EXP Saw will provide years of dependable service.

GENERAL DESCRIPTION

The MK-370EXP Saw Tile Saw is engineered as a tabletop or stand mounted wet tile saw. The saw includes a powerful 120v electric motor. The saw is capable of cutting tile up to eighteen (18) inches in length. The saw can cut an object two (2) inches thick in one pass.

MOTOR SPECIFICATIONS

Motor specifications for the MK-370EXP Saw are listed in the table below.

Voltage	120v
Overall Amperage	7.4 A
Frequency	50/60Hz
RPM	6000 rpm
Horse Power	1-1/4 hp

BLADE CAPACITY

The MK-370EXP Saw uses a seven (7) inch (178mm) diameter, wet cutting continuous rim, MK Diamond blade with a five-eighths (5/8) inch (15.875 mm) arbor.

TILE TYPES

The MK-370EXP Saw can cut a variety of tile types including stone, ceramic, slate, granite, marble, porcelain, and lapidary products.

NOTE: The MK-370EXP Saw is not designed to cut plastic or metals.

TILE SAW SPECIFIC WARNINGS

WARNING

Wear eye protection.

Use splash guard for every operation for which it can be used.

Disconnect saw before servicing, when changing cutting blades, and cleaning.

Replace damaged cutting blade before operating.

UNPACKING

⚠ CAUTION Use proper lifting techniques when lifting the MK-370EXP Saw. Remove the MK-370EXP Saw and accessory box from the carton.

CONTENTS:

- | | | |
|--|--------------------------------|-----------------------|
| One (1) MK-370EXP frame & water pan | One (1) pump discharge fitting | One (1) warranty card |
| One (1) MK-370EXP cutting head | One (1) cooling transfer tube | |
| One (1) 7-inch wet cutting blade | One (1) Flow adjusting clamp | |
| One (1) splash guard | One (1) blade wrench | |
| One (1) splash guard wing nut & washer | One (1) shaft wrench, | |
| One (1) extended rip guide | One (1) owners manual | |
| One (1) electric water pump | One (1) pump manual | |

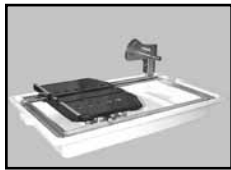

MK-370EXP
Frame & Water Pan



MK-370EXP
Cutting Head



Diamond Blade

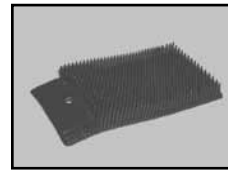

Splash Guard



Splash Guard
Wing Nut & Washer



Extended
Rip Guide



Electric
Water Pump



Pump
Discharge Fitting



Cooling
Transfer Tube



Flow
Adjusting Clamp



Blade Nut
Wrench



Shaft
Wrench



Owner's
Manual



Pump
Manual



Warranty
Card

TRANSPORT

- ⚠ CAUTION**
1. The MK-370EXP Saw weighs approximately thirty-three (33) pounds; use care when transporting.
 2. Never transport the MK-370EXP Saw with water in the Water Pan.

The MK-370EXP Saw is designed with a rigid frame and removable Cutting Head making the saw easily transportable. To lift the saw, grasp the front and back of the frame at the lift points shown below.

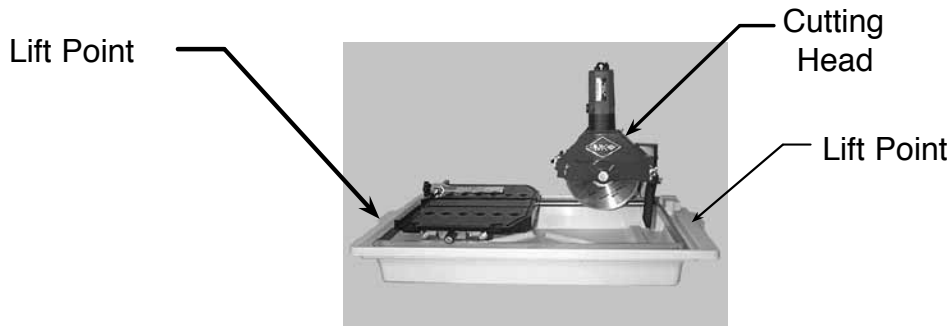

Follow the assembly instructions to prepare your MK-370EXP Saw for operation.

CUTTING HEAD INSTALLATION



(A)
Place the Flat Washer onto the Height Adjusting Knob

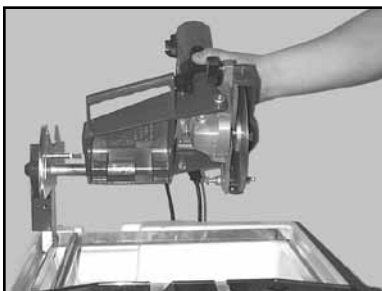

(B)
Align Cutting Head Pivot Hole to the Post, Pivot Shaft

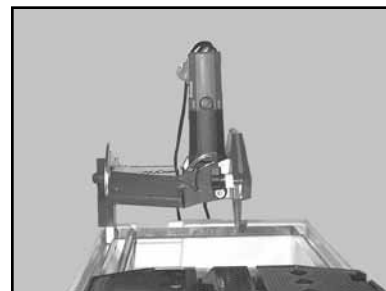

(C)
Verify the Cutting Head is completely installed and seated on the Post

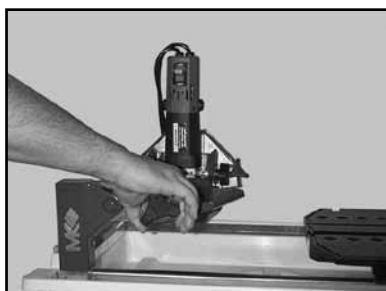

(D)
Install the Height Adjusting Knob through the Post into the Cutting Head and tighten the Knob

DIAMOND BLADE INSTALLATION

NOTE: When installing the Retaining Screw, do not "cross-thread" and DO NOT over tighten the screw.

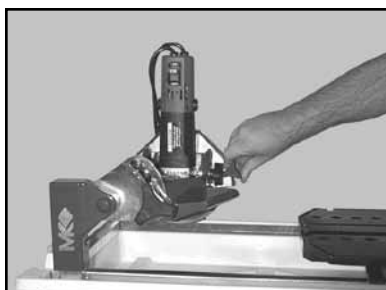

(A)
Loosen and remove the Blade Guard Retaining Knob

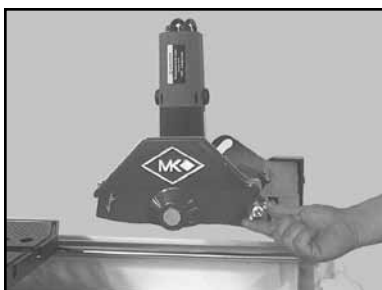

(B)
Loosen the Blade Guard Retaining Wing nut



(C)
Open the Blade Guard



(D)
Place the Shaft Wrench between the Inner Blade Guard and the Motor and onto the Motor Shaft

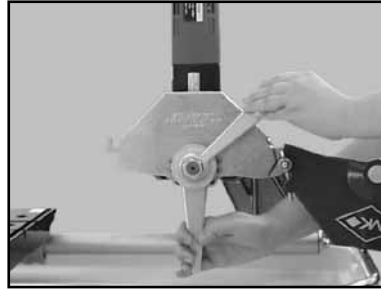

(E)
Using the Blade and Shaft Wrenches, loosen and remove the Retaining Nut and Outer Flange

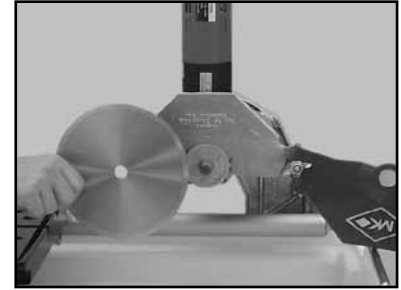

(F)
Install Diamond Blade onto Blade Shaft

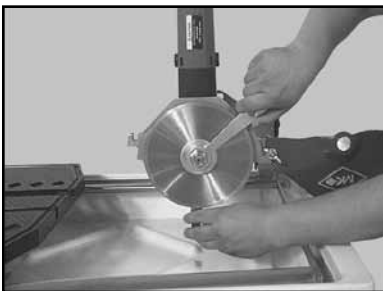

(G)
Install the Retaining Nut and Outer Flange and then tighten using the Blade and Shaft Wrenches

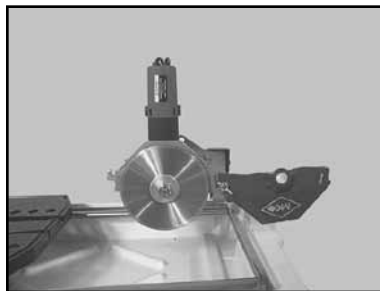

(H)
Close the Blade Guard



(I)
Verify the Blade is seated on the Blade Shaft and direction of rotation is correct

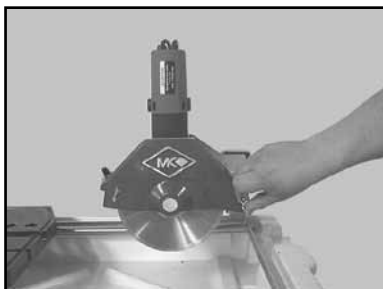

(J)
Tighten the Blade Guard Retaining Wing nut



(K)
Tighten the Blade Guard, Retaining Knob

ADJUSTABLE CUTTING GUIDE INSTALLATION

NOTE: The Adjustable Cutting Guide can be used on either side of the Diamond Blade.

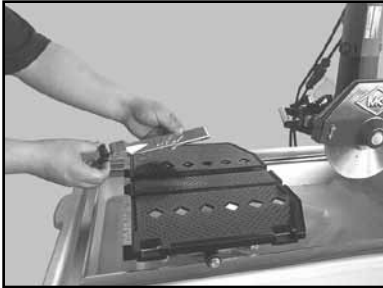

(A)

Loosen Adjustable Cutting Guide retaining thumbscrew and place it over the Movable Cutting Table, Ruler/Stop

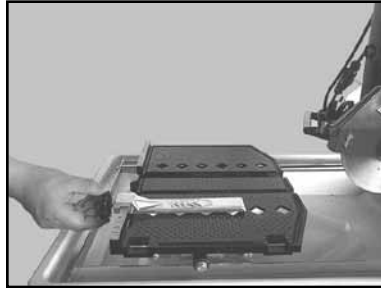

(B)

Place the Adjustable Cutting Guide onto the Movable Cutting Table Ruler/Stop and tighten the retaining thumbscrew

SPLASH GUARD INSTALLATION

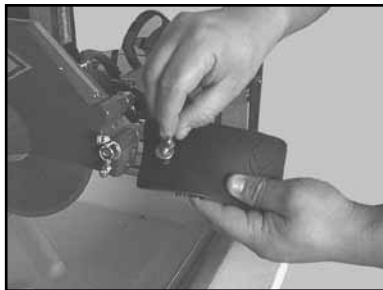

(A)

Install the retaining thumbscrew through the washer and Splash Guard then align to the hole found on back of the Blade Guard



(B)

Install the Splash Guard onto the Blade Guard

WATER PUMP PREPARATION

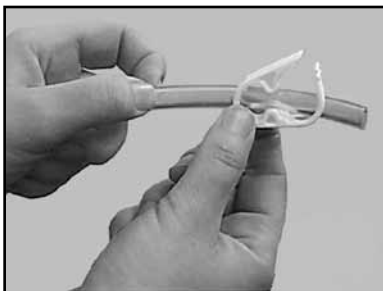

(A)

Slide Cooling Flow Adjusting Clamp onto the Cooling Transfer Tube



(B)

Press one end of the Cooling Transfer Tube onto the Water Pump Discharge Fitting

PRE-START INSPECTION

Prior to beginning work, a pre-start inspection of the saw should be performed.



(A)
Ensure the ON/OFF Switch is in the OFF position

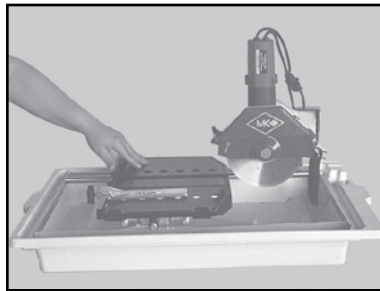

(B)
Verify the Movable Cutting Table moves freely

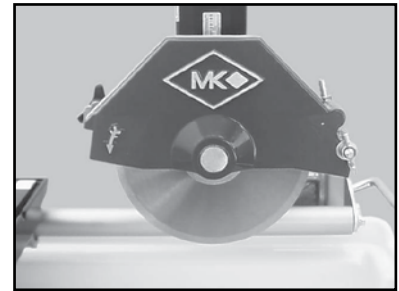

(C)
Inspect the Diamond Blade for damage – verify the blade is correct for the type of material being cut



(D)
Inspect the Pump Assembly for damage – ensure the cord is free of cracks or cuts

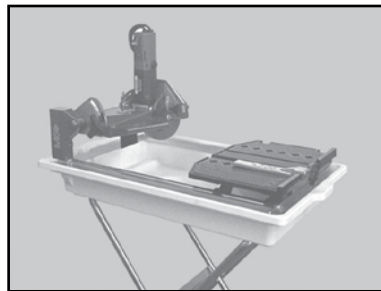

(E)
Inspect the MK-370EXP Saw for damage – ensure the cord is free of cracks or cuts

CONNECTING THE WATER PUMP**WARNING**

1. To prevent the possibility of electrical shock, the MK-370EXP Saw **MUST** be de-energized when connecting the Water Pump.
2. To prevent the possibility of electrical shock, use only MK Diamond authorized replacement parts.

NOTE: To prevent pump damage, the Water Pump must be disconnected if cutting dry.

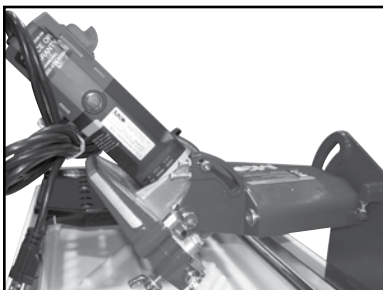

(A)
Loosen the cutting head pivot retaining knob and tilt cutting head to 45°



(B)
Connect the Cooling Transfer Tube to the inlet connection on the Blade Guard

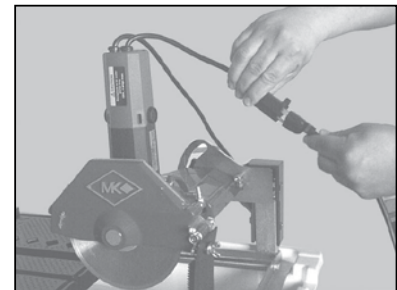

(C)
Connect the Water Pump power cord to the connection found on the back of the motor

WATER PUMP SETUP FOR OPERATION

The Water Pump can be setup for operation in two ways: External Water Source or Re-circulation.

NOTE: If cutting dry DO NOT connect the water pump.

RE-CIRCULATION

NOTE: When using the re-circulation method, the water should be changed often for longer pump life

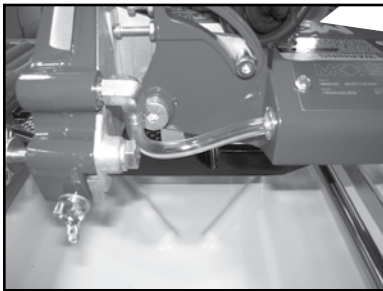

(A)
Ensure that Cooling Transfer
Tube is connected

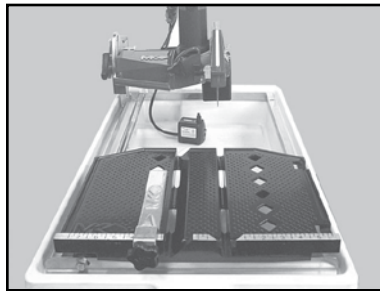

(B)
Place the Water Pump toward
the back of the Water Pan

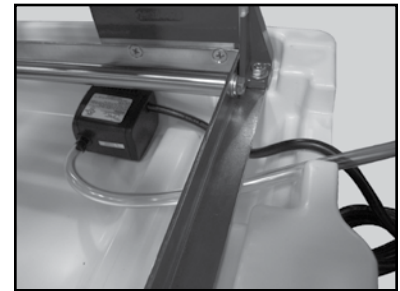

(C)
Position pump as shown and
place the pump electrical
cord and cooling transfer tube
under the frame.

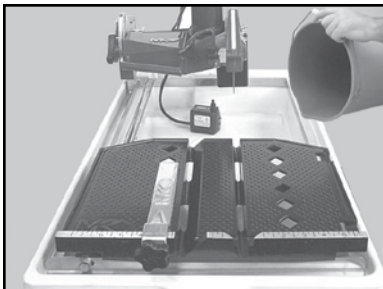

(D)
Fill the Water Pan until water
completely covers the Water
Pump suction

EXTERNAL WATER SOURCE

This is the preferred method of cooling.

1. Verify or remove the Drain Plug from the Water Pan.
2. Place the Water Pump in an external container.
3. Fill the external container until water completely covers the Water Pump suction inlet.
4. Place an external catch basin below the Water Pan drain hole.

SETUP FOR OPERATION

**CAUTION**

1. Before powering or starting, check for damage that could prevent this equipment from proper operation or performing its intended function. Check for binding and alignment of moving parts. Check for damaged, broken, or missing parts.
2. Verify the On/Off switch is in the OFF position.
3. Before connecting the MK-370EXP Saw to a power supply, be sure the voltage, cycle and phase of the job site power source meet the requirements of the table below.
4. Plug the MK-370EXP Saw into a wall outlet with built-in GFCI protection.
5. Do not cover the motor vents as this could lead to motor overheating.

VOLTAGE	120v
CYCLE	60Hz
PHASE	1-phase

- NOTE:** 1. If using an extension power cord, make sure the length and wire gauge correspond to the requirements listed in on page 10. An extension power cord that is too small in wire gauge (diameter), or too long in length, will cause the motor to overheat and could cause premature failure.

CUTTING STRAIGHT EDGES

⚠ CAUTION DO NOT FORCE THE TOOL. It will do the job better and safer at the rate for which it was designed.

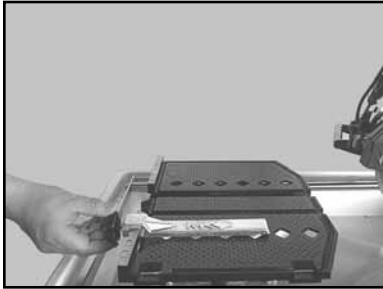

(A)
Loosen the Adjustable Cutting Guide retaining thumbscrew



(B)
Position the Adjustable Cutting Guide to desired cut length

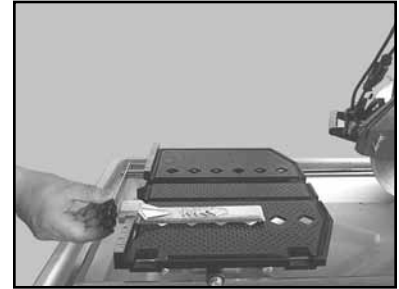

(C)
Tighten the retaining thumbscrew



(D)
Place the tile against the Ruler/Stop and Cutting Guide



(E)
Turn the motor ON

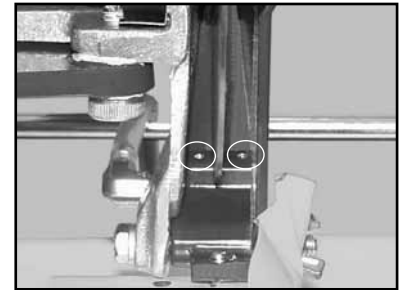

(F)
Verify cooling flow on both sides of the blade



(G)
Perform the cut



(H)
Turn the motor OFF when work is complete

CUTTING 45° MITERS

The MK-370EXP Saw is designed with an adjustable Cutting Head for precision 45° Miter Cuts.

⚠ CAUTION DO NOT FORCE THE TOOL. It will do the job better and safer at the rate for which it was designed.

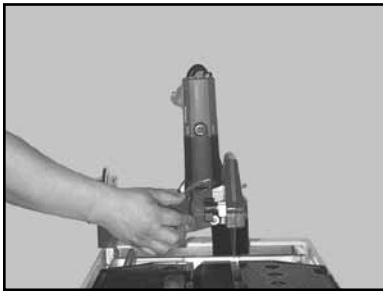

(A)
Loosen the Cutting Head
Pivot, Retaining Knob

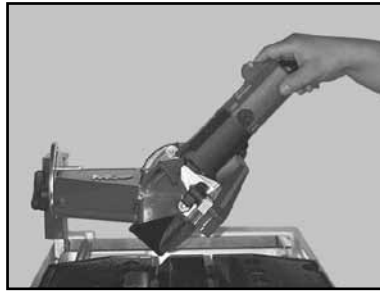

(B)
Pivot the Cutting Head to
the 45° cutting position

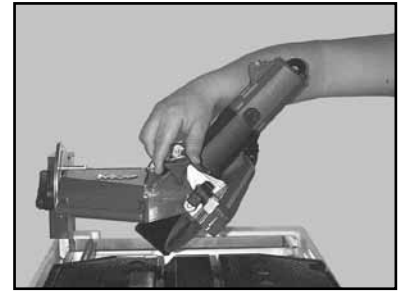

(C)
Tighten the Cutting Head,
Pivot Retaining Knob

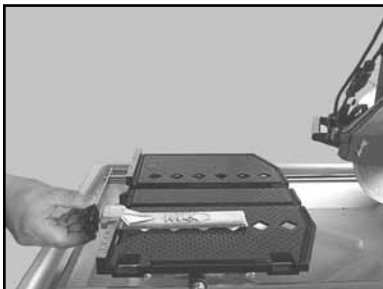

(D)
Loosen the Adjustable
Cutting Guide retaining
thumbscrew



(E)
Position the Adjustable
Cutting Guide to desired cut
length

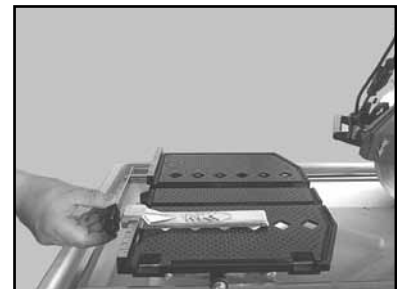

(F)
Tighten the retaining
thumbscrew

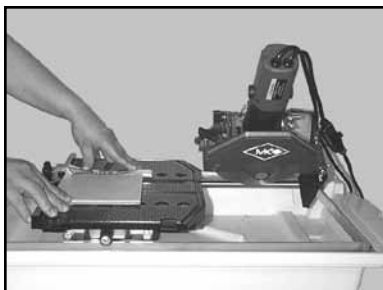

(G)
Place the tile against the
Ruler/Stop and Cutting
Guide



(H)
Turn the motor ON

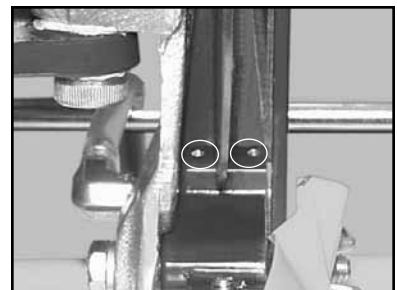

(I)
Verify cooling flow on both
sides of the blade

CUTTING 45° MITERS (CONT...)

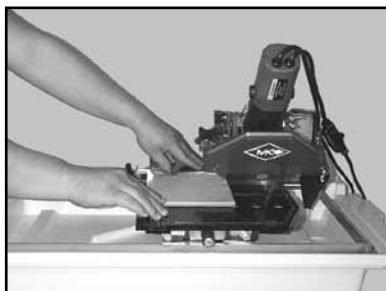

(J)
Perform the cut



(K)
Turn the motor OFF when
work is complete

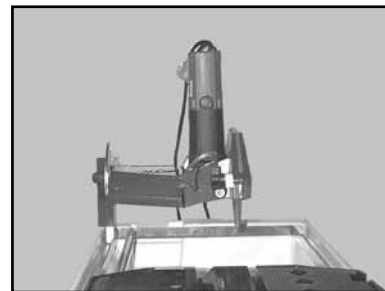

(L)
Return the Cutting Head to the
upright position when complete

DIAGONAL CUTTING

NOTE: To cut diagonal, the Dual 45° Flat Angle Guide (MK Diamond Part No. 134557-MK) should be used.

! CAUTION DO NOT FORCE THE TOOL. It will do the job better and safer at the rate for which it was designed.

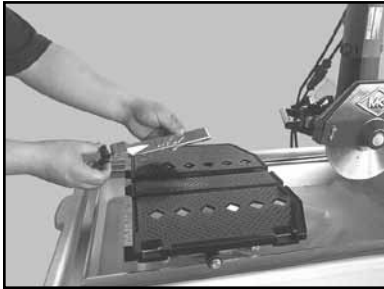

(A)
Remove the Adjustable Cutting Guide

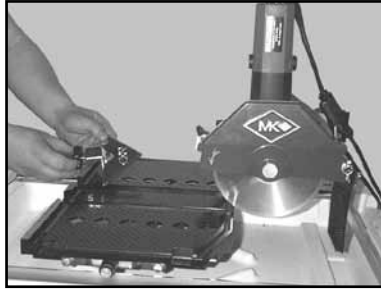

(B)
Place the Dual 45° Flat Angle Guide on the Ruler/Stop



(C)
Position the Dual 45° Flat Angle Guide and tighten the retaining knob

If Cutting the tile in two equal halves, align the tile in the V-notch of the Movable Cutting Table Ruler/Stop.

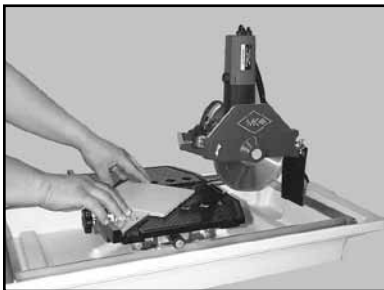

(D)
Position the tile against the Dual 45° Flat Angle Guide and the Ruler/Stop



(E)
Turn the motor ON

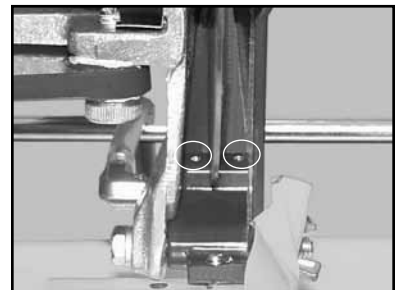

(F)
Verify cooling flow on both sides of the blade



(G)
Perform the cut



(H)
Turn the motor OFF when work is complete

OFF-ANGLE CUTTING

NOTE: Use a Protractor (MK Part No. 134569-MK) to cut angles other than 45° angles. (not included)

! CAUTION DO NOT FORCE THE TOOL. It will do the job better and safer at the rate for which it was designed.

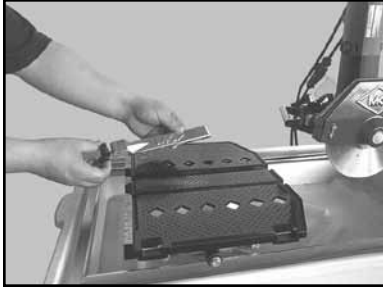

(A)
Remove the Adjustable Cutting Guide

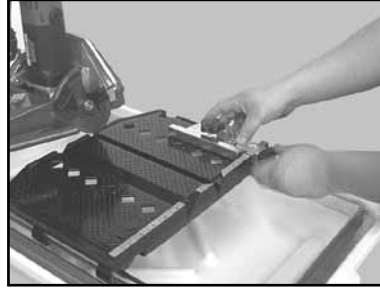

(B)
Place the Protractor on the Ruler/ Stop. Turn CCW to loosen

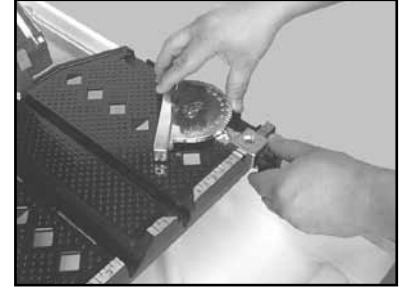

(C)
Set the desired angle on the Protractor Gage

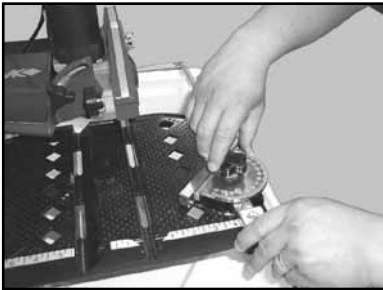

(D)
Tighten the Protractor Gage retaining knob

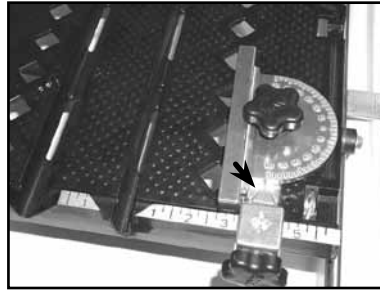

(E)
Position the Protractor Cutting Guide to the desired length

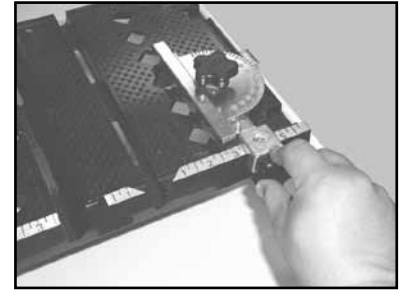

(F)
Tighten the retaining knob

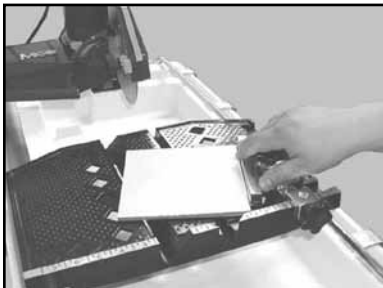

(G)
Position the tile against the Protractor and the Ruler/Stop



(H)
Turn the motor ON

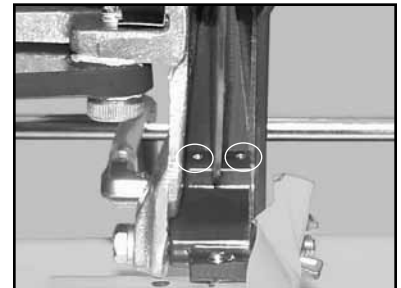

(I)
Verify cooling flow on both sides of the blade

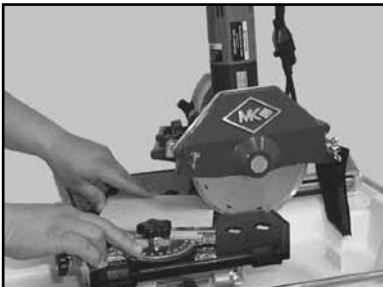

(G)
Perform the cut



(H)
Turn the motor OFF when work is complete

CLEANUP

NOTE: Dispose of wastewater in accordance with applicable Federal, State and Local laws.



(A)
Remove the pump Suction Screen and clean the Water Pump of all debris.
(See pump manual for more detail)

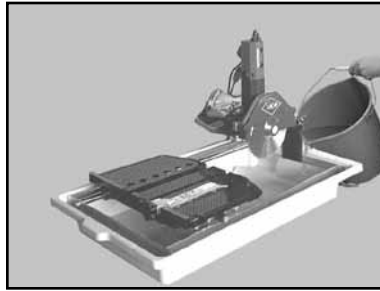

(B)
Fill the Water Pan with clean water

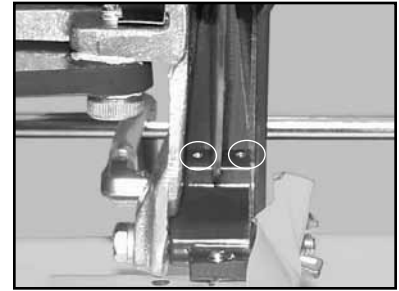

(C)
Run the MK-370EXP Saw until clear water is seen at the blade Cooling Flow Points (Approx. 1 minute)



CAUTION Ensure the saw is disconnected before completing the remainder of the cleanup process.



(D)
Ensure the ON/OFF Switch is in the OFF position. Unplug the saw from the Power source



(E)
Remove the Cutting Assembly from the Water Pan



(F)
Dispose the contents of the Water Pan



(G)
Clean the MK-370EXP with soap and clean water



(H)
Clean the Water Pan



(I)
Clean the Adjustable Cutting Guide and Guide Bar

! CAUTION Ensure water is not forced into the motor casing when cleaning.



(J)
Clean the Roller Wheel
Guide Rail

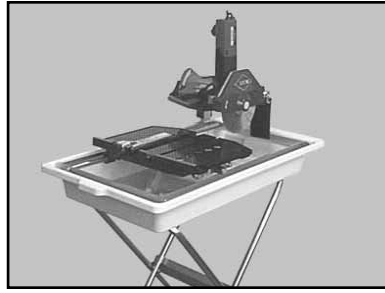

(K)
Clean the remainder of the
MK-370EXP Saw

MAINTENANCE FOLLOWING USE

To extend the life of the MK-370EXP Saw, the following procedure should be performed after each use. Lubricate all points listed below with light oils such as, 3 in 1, WD-40, etc.



(A)
Ensure the ON/OFF Switch
is in the OFF position

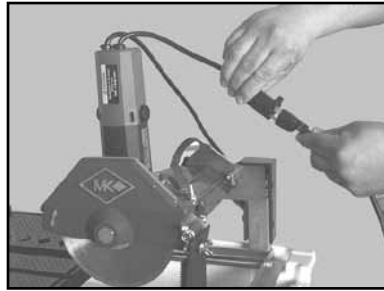

(B)
Unplug MK-370EXP Saw

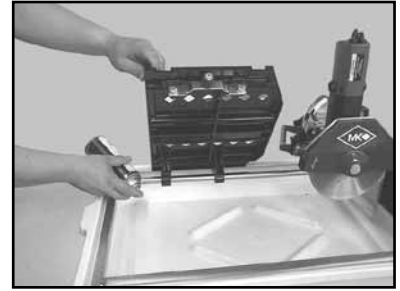

(C)
Lubricate the Guide Bar

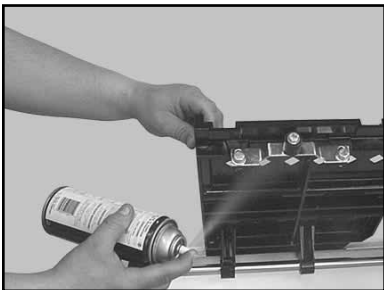

(D)
Lubricate the Roller
Wheel Assembly

MONTHLY MAINTENANCE

The following maintenance should be performed Monthly.

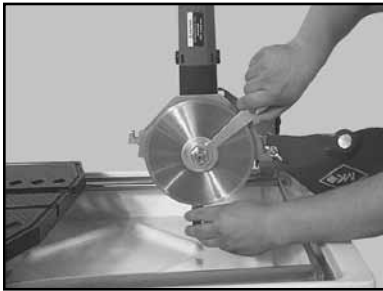

(A)
Remove the Diamond
Blade, Outer Flange and
Retaining Nut

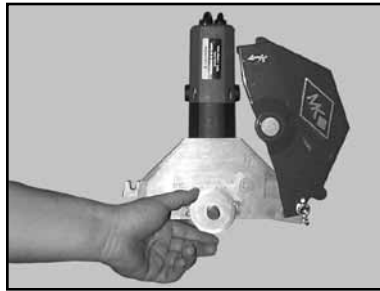

(B)
Remove the Inner Flange

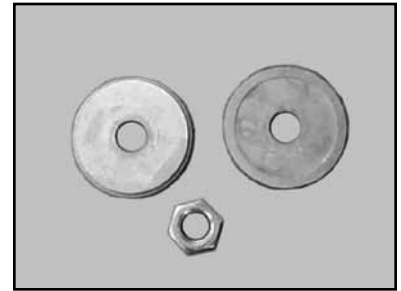

(C)
Clean and Lubricate the
Inner and Outer Flanges
and the Retaining Nut



(D)
Clean around Motor Shaft

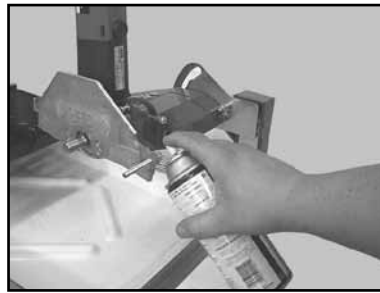

(E)
Remove the Blade Guard
then clean and lubricate the
Blade Guard Pivot Shaft

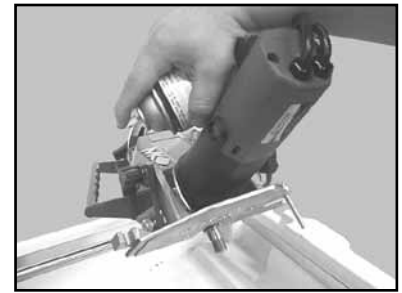

(F)
Lubricate the front Cutting
Head Pivot Point



(G)
Lubricate the rear Cutting
Head Pivot Point

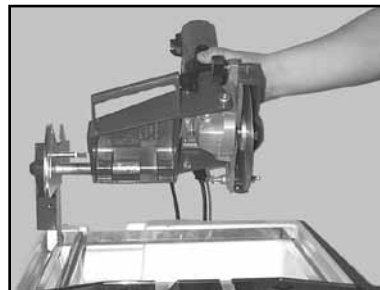

(H)
Remove the Cutting Head



(I)
Clean the Cutting Head
Pivot Holes



(J)
Lubricate the Cutting Head
Pivot Holes

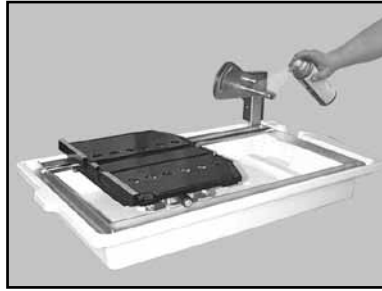

(K)
Lubricate the Cutting Head
Pivot Shaft



(L)
Lubricate the Cutting Head
Adjustment Knob

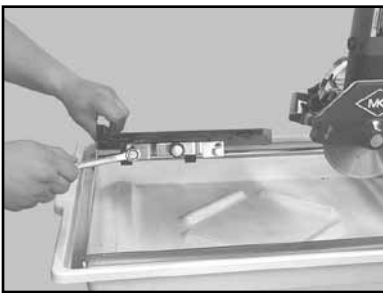

(M)
Verify the Cutting Table Roller
Wheel Assembly is tight

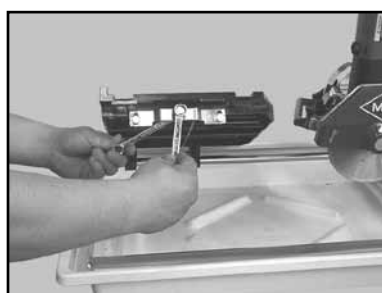

(N)
Verify that the Roller Wheel
is tight

FLOW ADJUSTMENT

NOTE: If flow to the diamond blade requires adjustment, perform the following actions.

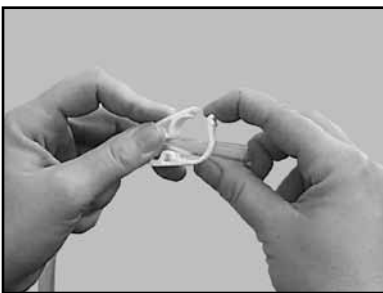

(A)
Increase cooling flow by
releasing the Flow Adjusting
Clamp

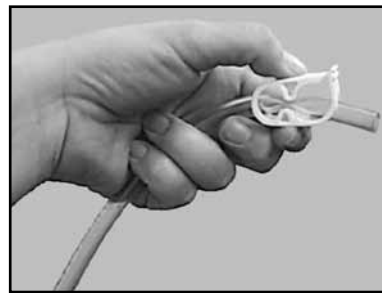

(B)
Reduce cooling flow by
pressing down on the Flow
Adjusting Clamp

BLADE DRESSING

Like most cutting instruments, a diamond blade performs best when it is dressed. Over time and use, diamonds on the outer edge of the blade will become smoothed or "glazed" over.

This will reduce grinding efficiency and may cause the blade to "wander" or bend giving the illusion of an alignment problem. When this occurs, the blade will need to be dressed.

The diamond blade can be dressed using the MK Dressing Stick (part# 152792) and by following the steps below.

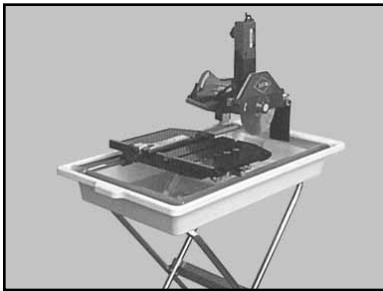

(A)

Setup the MK-370EXP Saw for operation (See Setup, Adjustment and Operation)

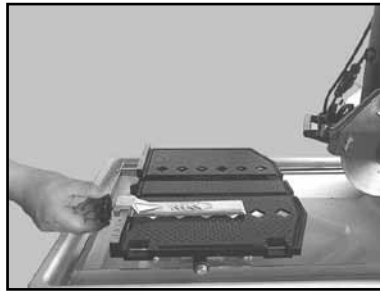

(B)

Set the Adjustable Cutting Guide to cut a 1/16-strip

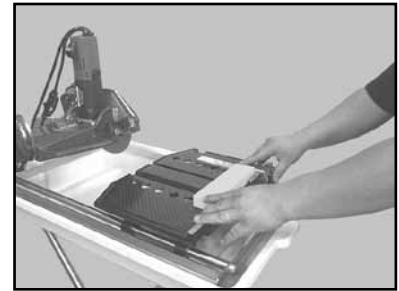

(C)

Position the Dressing Stick



(D)

Turn the motor ON

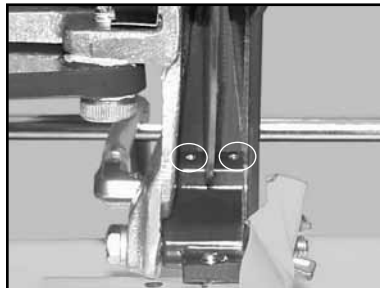

(E)

Verify cooling flow on both sides of the blade

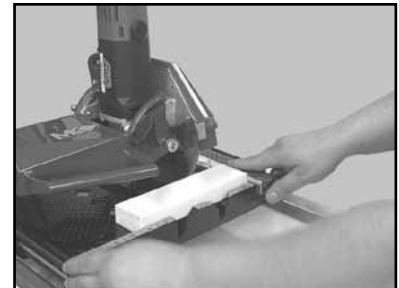

(F)

Cut the Dressing Stick 7 or 8 times to dress the Blade



(G)

Ensure the ON/OFF Switch is in the OFF position

DIAMOND BLADE CHANGE-OUT

NOTE: When installing the Retaining Nut, do not "cross-thread" and DO NOT over tighten the screw.

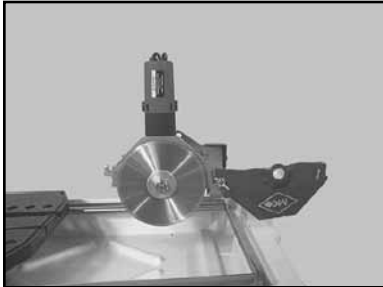

(A)
Open the Outer Blade

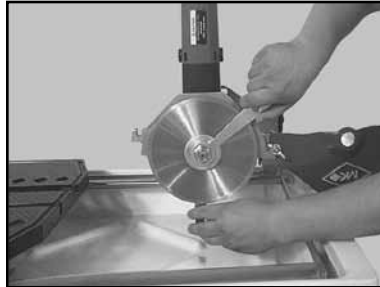

(B)
Remove Retaining Nut and
Outer Flange

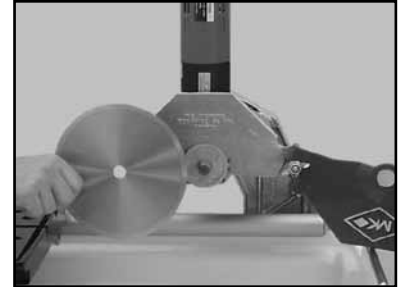

(C)
Remove Diamond Blade
from Blade Shaft

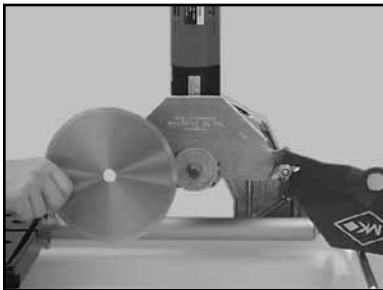

(D)
Install the Diamond Blade
onto Blade Shaft

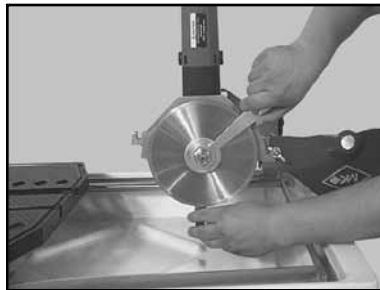

(E)
Install the Retaining Nut
and Outer Flange and then
tighten using the Blade and
Shaft Wrenches

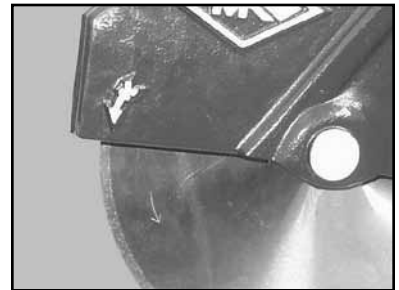

(F)
Verify the Blade is seated on
the Blade Shaft and direction
of rotation is correct



(G)
Close the Outer Blade

ALIGNMENT

The Movable Cutting Table of the MK-370EXP Saw is pre-aligned in the factory. It may become misaligned with the Cutting Head of the Tile Saw over time. Should misalignment occur, perform the following steps to realign it.

NOTE: If alignment problems are the result of a warped blade, a bent frame or bent support arm, or, if alignment is off by more than 1/8-inch, contact the MK Diamond Service Center - (800) 474-5594

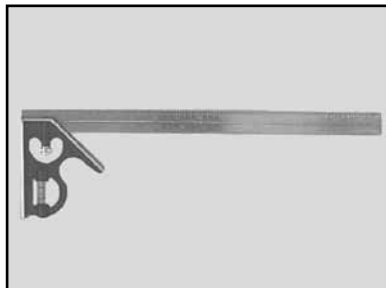
TOOLS NEEDED:

Combination Square
12-inch or Greater



1/2-inch Wrench



1/4-inch Wrench

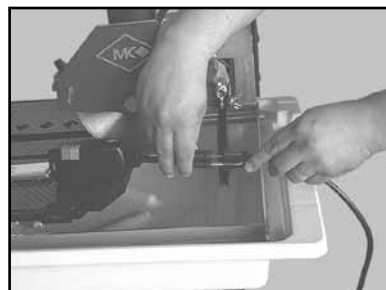

Flat Head Screwdriver

PREPARATION

(A)
Remove Tile Saw
from Power Source



(B)
Inspect Tile Saw
for damage

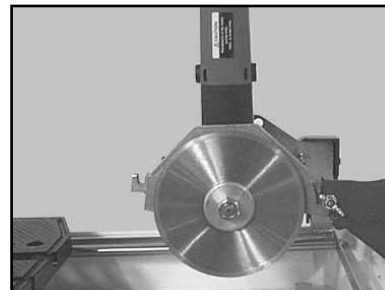

(C)
Inspect Diamond Blade
for damage

MOVABLE CUTTING TABLE ALIGNMENT VERIFICATION

This will verify the Movable Cutting Table is aligned to the frame of the saw.

NOTE: If the blade is misaligned following alignment verification, attempt to align using Alignment Screw, 90° Verification. The Diamond Blade must be removed and reinstalled when removing the Blade Guard.

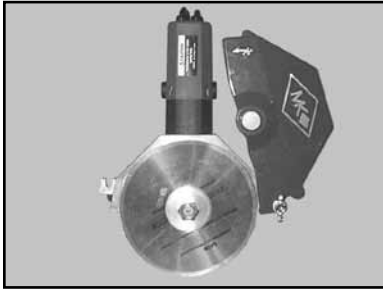

(A)
Remove Blade Guard

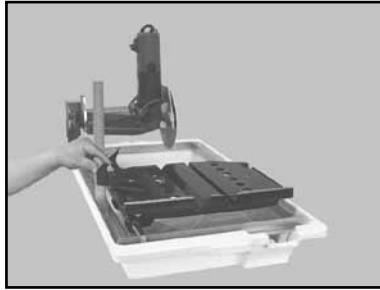

(B)
Place Square on guide bar
side of cutting table

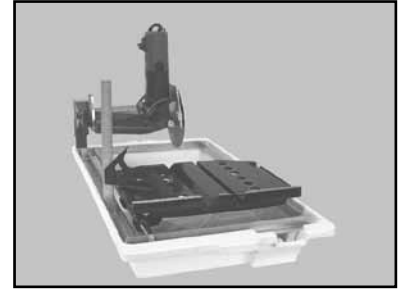

(C)
Lock in position

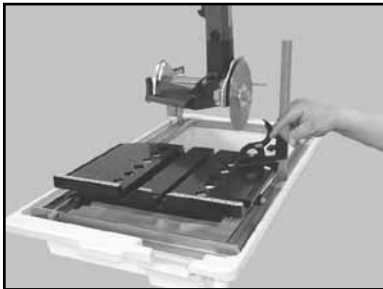

(D)
Move Square to wheel
assembly side of the cutting
table

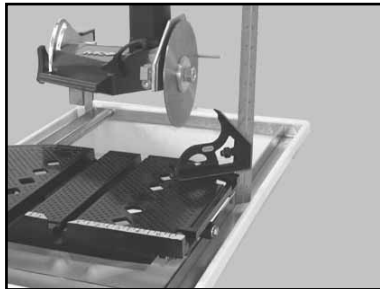

(E)
Verify Wheel Assembly side of
Movable Cutting Table height
is same as Guide Bar side

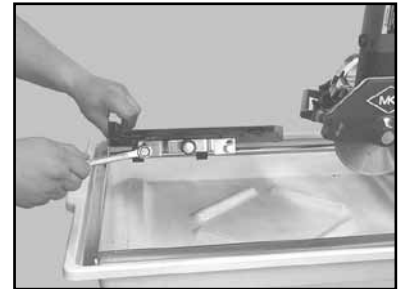

(F)
If gap exists, loosen Movable
Cutting Table Wheel Assembly

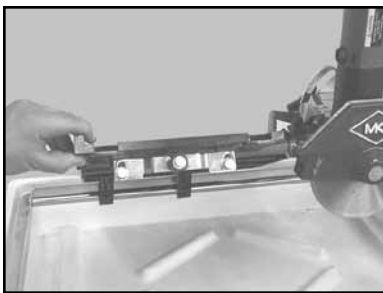

(G)
Move Wheel Assembly up or
down to Square the Movable
Cutting Table

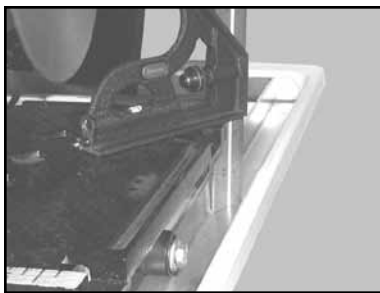

(H)
Check that there is no gap
between the Square and the
wheel assembly side of frame

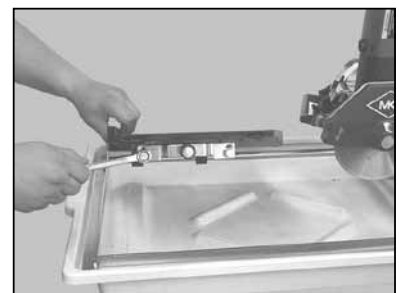

(I)
Tighten Movable Cutting
Table Wheel Assembly

ALIGNMENT SCREW, 90° VERIFICATION

90°- alignment verification will ensure that the blade will cut the tile straight up and down and not at an angle.

NOTES: If the blade is misaligned following this alignment procedure, return the saw to MK Diamond for repair. The Diamond Blade must be removed and reinstalled when removing the Blade Guard.

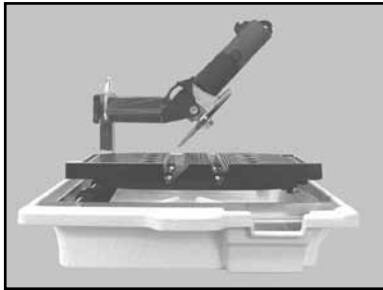

(A)
Position the Cutting Head to the 45° Cutting Angle

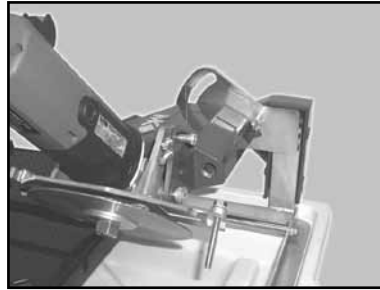

(B)
Locate the 90° Adjustment Screw

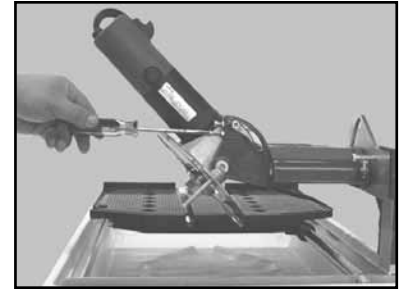

(C)
Rotate 90° Adjustment Screw clockwise or counter-clockwise to realign Cutting Head

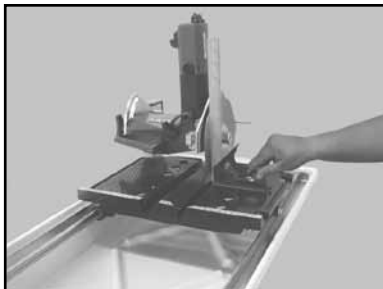

(D)
Position the Square on Movable Cutting Table against the Diamond Blade

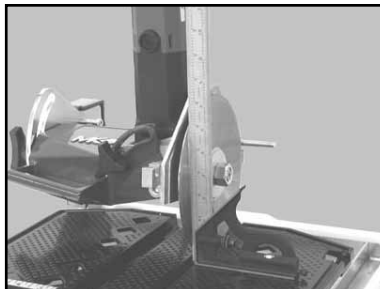

(E)
Verify the Diamond Blade is Square to the Movable Cutting Table



(F)
Repeat Steps A to E as necessary to align the Cutting Head

HORIZONTAL ROUGH ALIGNMENT

The Horizontal alignment will ensure that straight cuts (or Rip Cuts) are made.

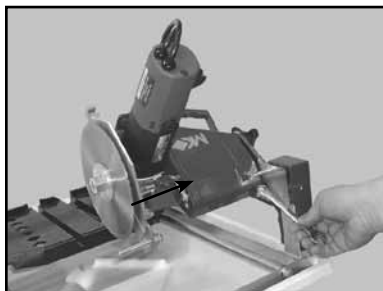

(A)
Position Cutting Head to normal Cut Depth

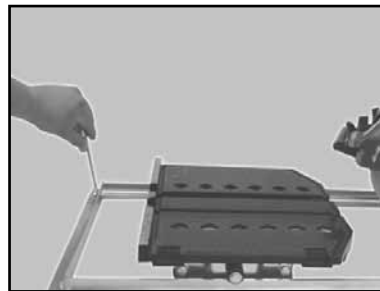

(B)
Loosen front and rear Guide Bar Retaining Bolts

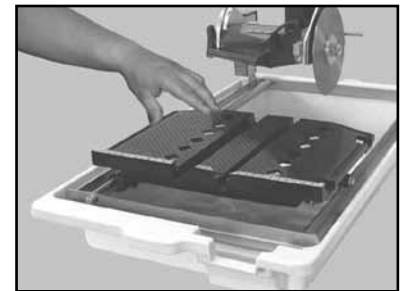

(C)
Move Guide Rail and Table until the Blade is centered in Cutting Groove

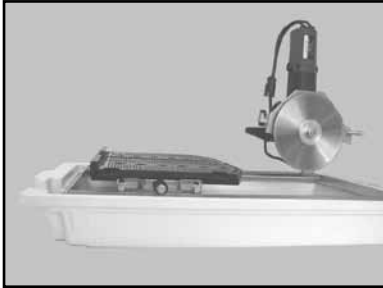
HORIZONTAL FINAL ALIGNMENT

(A)
Pull Movable Cutting Table
to front of Tile Saw

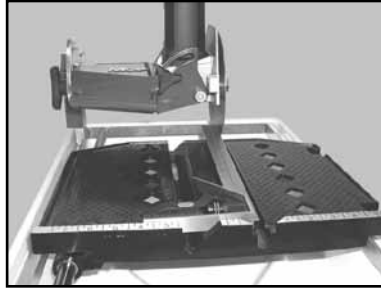

(B)
Position Square flat on Movable
Cutting Table against Ruler/Stop

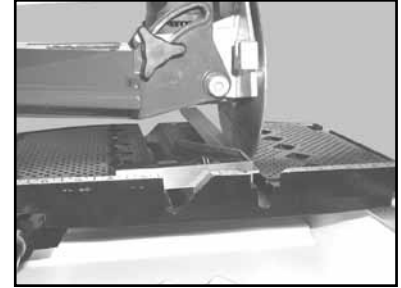

(C)
Position front of Square
against Blade



(D)
Move Guide Bar and table
until Square rests evenly
across Blade

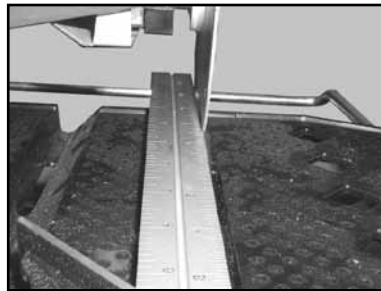

(E)
Position end of Square
against Blade

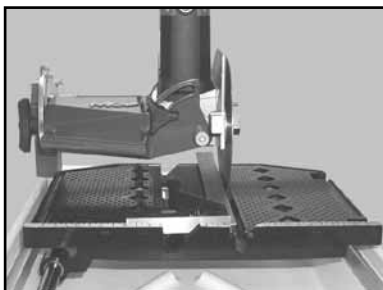

(F)
Move Guide Bar and table
until Square rests evenly
across Blade

HORIZONTAL ALIGNMENT VERIFICATION

(A)
Move the Cutting Table
back and forth to verify
Blade is even
across all points of Square

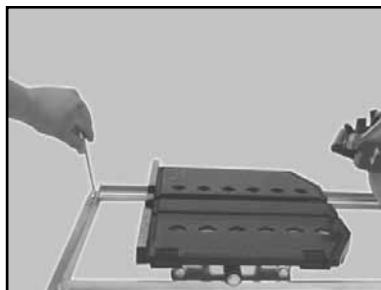

(B)
Tighten Guide Bar
Retaining Bolts

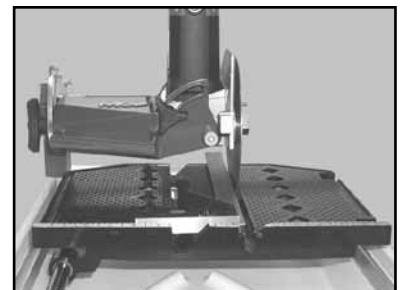

(C)
Move the Cutting Table
back and forth to re-verify
Blade is even across all points of
Square

45° ALIGNMENT VERIFICATION

The 45° Alignment Verification is done to ensure the blade will cut tile at a 45° angle.

NOTE: If the blade is misaligned following this alignment procedure, return the saw to MK Diamond for repair. The Diamond Blade must be removed and reinstalled when removing the Blade Guard.

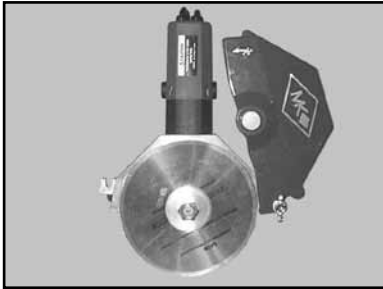

(A)
Remove Blade Guard
(If not done Previously)

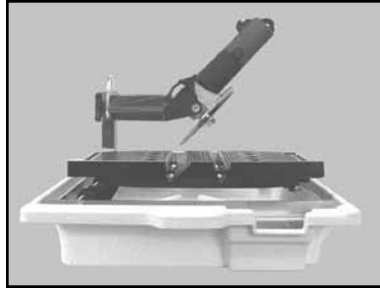

(B)
Position the Cutting Head
to the 45° Cutting Angle

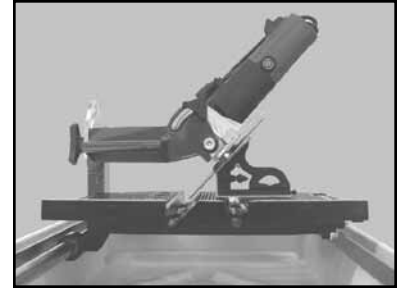

(C)
Place Square on the Movable
Cutting Table and position the
Square against the Blade

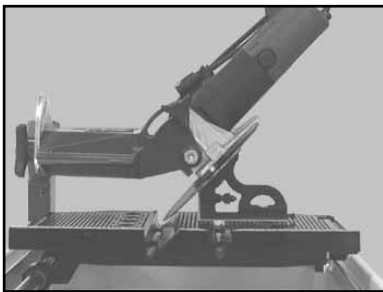

(D)
Verify Blade is even
across all points of Square
and there are no gaps
between Blade and Square

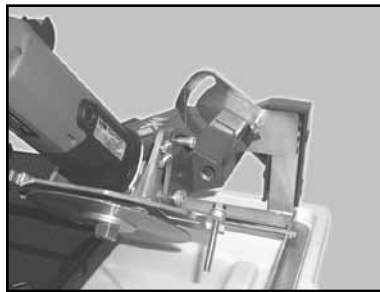

(E)
To Adjust 45° Cutting Angle,
locate the 45° Adjustment
Screw

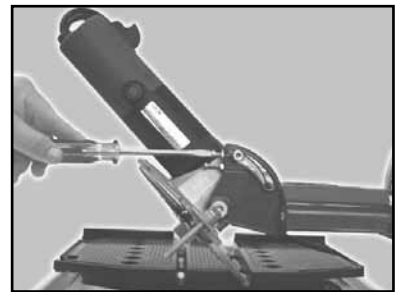

(F)
Rotate 45° Adjustment Screw
clockwise or counter-clockwise
to realign 45° Cutting Angle

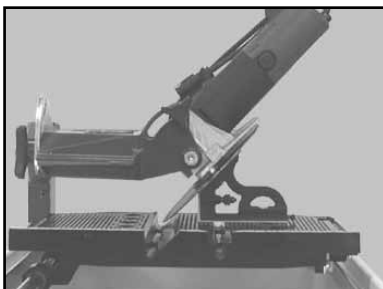

(G)
Verify Blade is now even
across all points of Square

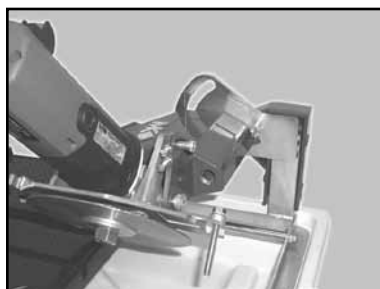

(H)
Repeat steps A to G until Blade is
even across all points of Square

BLADE WILL NOT CUT PROPERLY



(A)
Check for Smoothness or "Glazing" (Dress blade if needed)

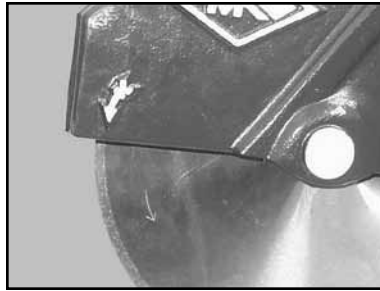

(B)
Check for proper rotation



(C)
Ensure the Blade Core is not bent and Arbor is not out of round



(D)
Verify the blade is correct for the material being used

MOVABLE CUTTING TABLE DOES NOT MOVE CORRECTLY



(A)
Check that the Guide Bar is clean – clean if dirty

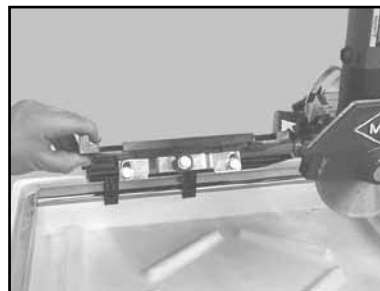

(B)
Check the Movable Cutting Table Roller Wheel for wear replace if necessary

COOLING FLOW

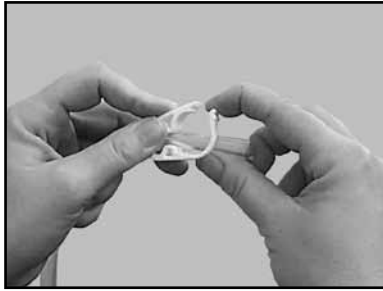

(A)
Check cooling flow
Adjusting Clamp open

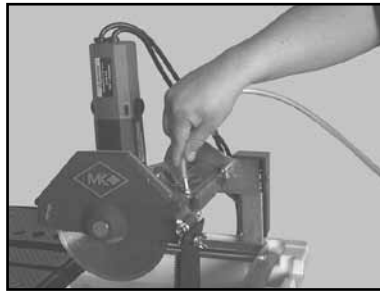

(B)
Remove the Cooling
Transfer Tube from the
Blade Guard inlet

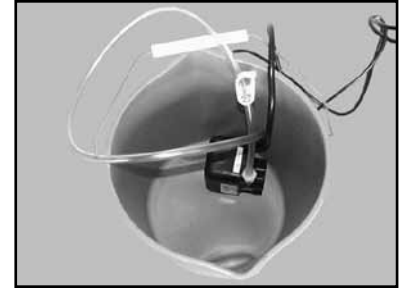

(C)
Place Pump into a bucket
of water and check flow



(D)
Remove the Cooling
Transfer Tube and check
flow



(E)
Remove the Pump
Discharge Fitting and check



(F)
Remove the Pump Intake
Screen and check for debris



(G)
Remove the Blade Guard
Intake Fitting



(H)
Clean the Blade Guard
Intake Fitting

NOTE: “Rodding” cooling channels is performed by inserting a small wire rod through the cooling inlet on top of the Blade Guard and directing the rod out through each of the cooling flow tubes located on the underside of the Blade Guard. The cooling channels should be “rodded” until all ports are free of foreign debris.

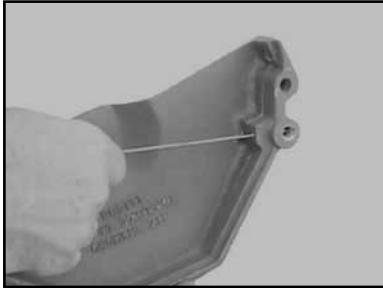

(K)
Rod Cooling Channels and
recheck flow

BLADE STOPS TURNING

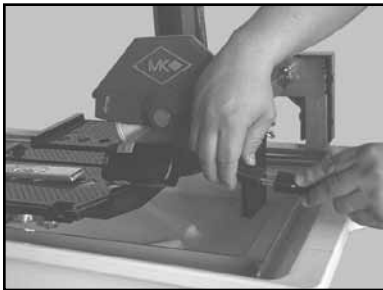

(A)
Verify all plugs are fully
installed

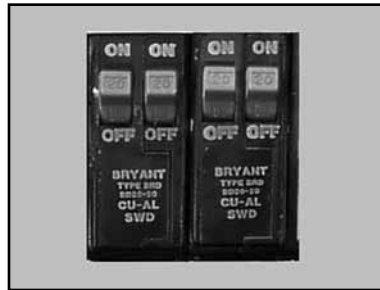

(B)
Check to see if the wall outlet
Ground Fault Circuit Interrupter
(GFCI) is tripped. Verify circuit
breaker not tripped. If tripped,
reset once

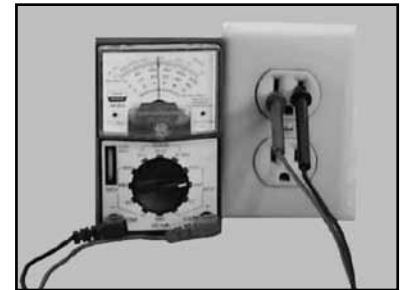

(C)
Check power source voltage
is 120v – if not 120v, move to
another circuit

TILE SAW ASSEMBLY
PART# 159943

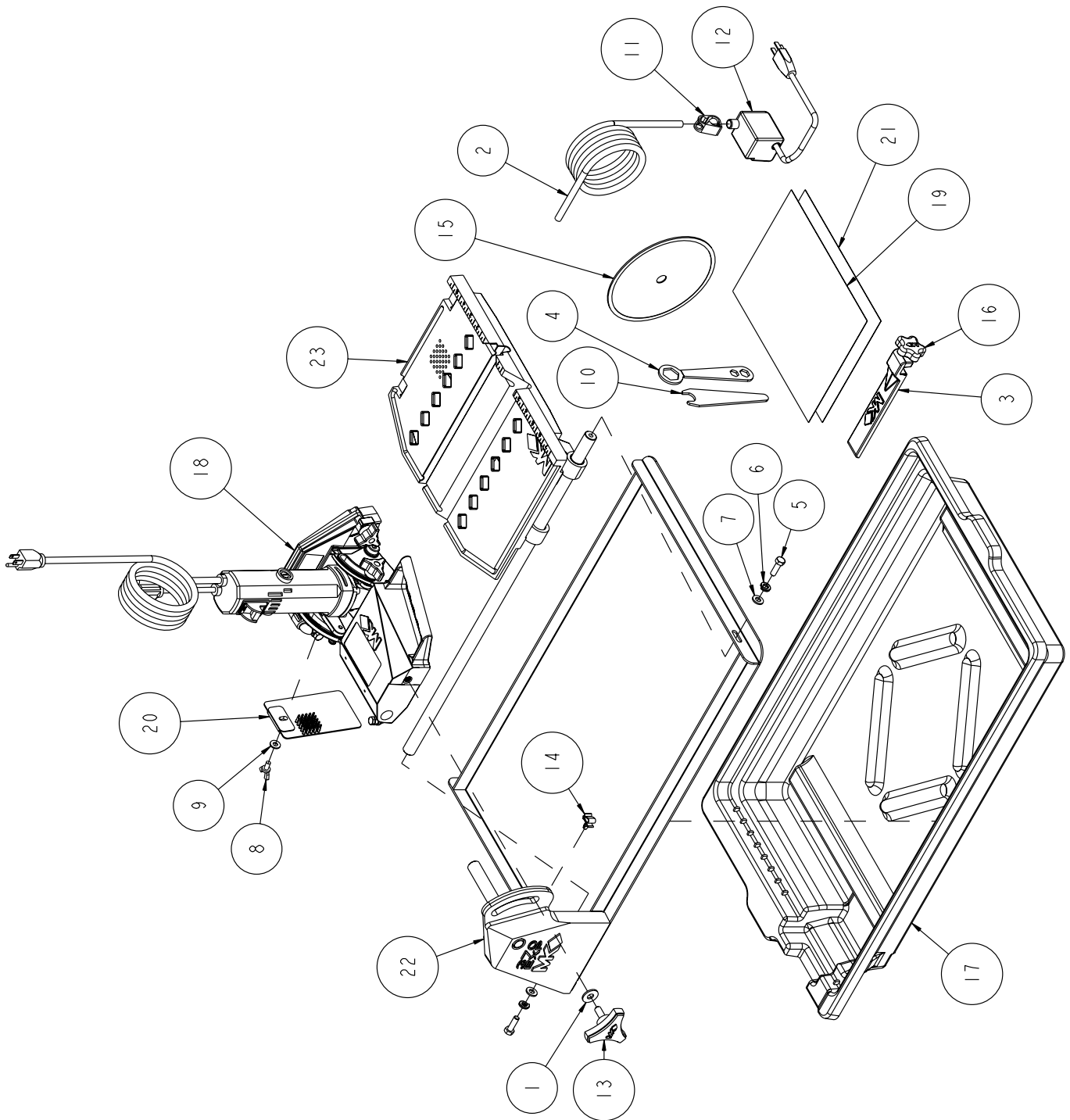

ITEM.	DESCRIPTION	QTY.	PART #
1	WASHER, FLAT CUT 3/8	1	101360
2	HOSE, WATER VINYL 1/2 X 3/8 TSAW (6.0')	1	132951
3	CASTING, ACC RIP GUIDE - COMP	1	134551
4	WRENCH, TILES AW, 15/16 - 18 X 1	2	134684
5	SCREW, HEX HD, 5/16 - 18 X 1	2	151743
6	WASHER, LOCK, SPLIT, 5/16	2	151747
7	WASHER, FLAT, SAE, 5/16	2	151754
8	SCREW, WING, 1/4 - 20 X 1/2	1	151888
9	WASHER, 1/4 SAE FLAT	1	151915
10	WRENCH, TILES AW, 11/16 OPEN END	1	153450
11	CLAMP, HOSE 1/2 - 3/4	1	154394
12	PUMP, WATER, 115V 60HZ	1	155987-VP
13	KNOB, TRI PLASTIC, 1"	1	156770-01
14	CLIP, CORD 1/4" PUSH MOUNT	1	157259
15	MK-HDTCM WET 7 X 060 X 7/8 CONT	1	157913
16	KNOB, RUBBER, 1/4 -20 X 3/4" LONG	1	159428-1
17	PAN, WATER MK-370EXP/1080	1	160041
18	ASSY, CUTTING HEAD, 120V	1	160042
19	OWNERS MANUAL MK-370EXP	1	160084
20	GUARD, SPLASH	1	160310
21	SHEET, WARNING LABELS, TILE SAW	1	166012
22	ASSY, FRAME, 370EXP	1	167450
23	ASSY, TABLE, 370EXP	1	168025

**CUTTING HEAD ASSEMBLY
PART# 160042**

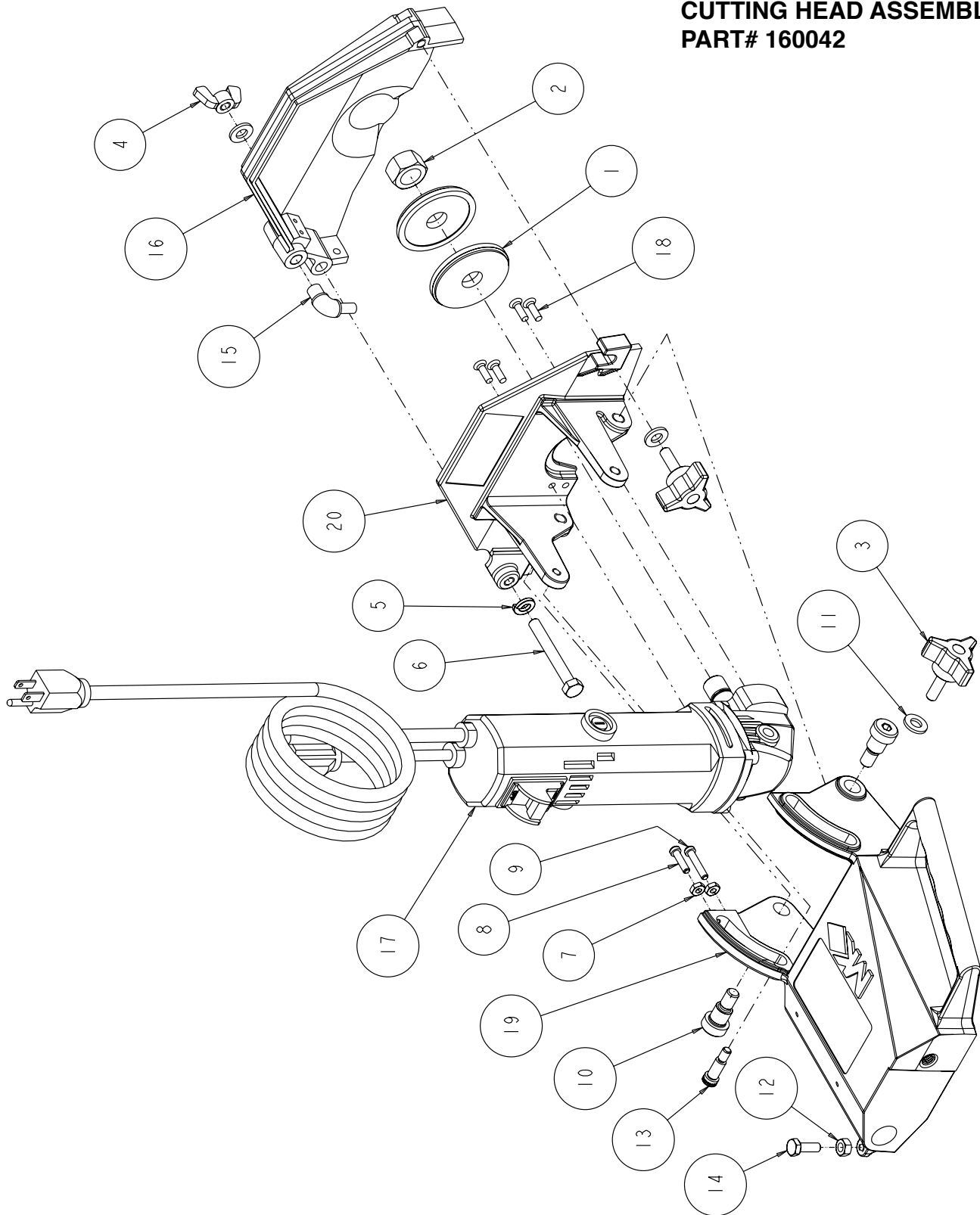

ITEM.	DESCRIPTION	QTY.	PART #
1	FLANGE, OUTER, 2-3/8	2	135830
2	NUT,HEX, 5/8 - 18	1	135848
3	KNOB, DAVIES, 5/16 - 18 X 1	2	151681
4	NUT, WING, NYLK, 5/16 - 18	1	151746
5	WASHER, LOCK, SPLIT, 5/16	1	151747
6	BOLT, HEX HD TAP, 5/16 - 18 X 2 - 1/2	1	151748
7	NUT, HEX, 10-24	2	151749
8	SCREW, FIL HD, SLT, #10 - 24 X 3/4	1	151750
9	SCREW, FIL HD, SLT, #10 - 24 X 1	1	151751
10	SCREW, SHOULDER, 1/2 X 1/2	2	151753
11	WASHER, FLAT, SAE, 5/16	3	151754
12	NUT, HEX, 1/4 - 20	1	1515893
13	SCREW SHOULDER 5/16 X 5/8	1	152137
14	SCREW HEX HD, 1/4 - 20 X 3/4	1	152370
15	ELBOW, 1/8 MNPT X 1/4 BARB 90DEG	1	154652
16	CASTING, BLD GRD, 7 INCH BLADE (COMP)	1	154811
17	MTR, ELECT, 7.4 AMP 120V	1	156428-R
18	SCREW, FLAT HD 10 -32 X 5/8"	4	157554
19	CASTING, COMMON PART, CTTG HD-C	1	159937
20	CASTING, MTR MOUNT, COMMON-COMP	1	159941

**TABLE ASSEMBLY
PART# 168025**

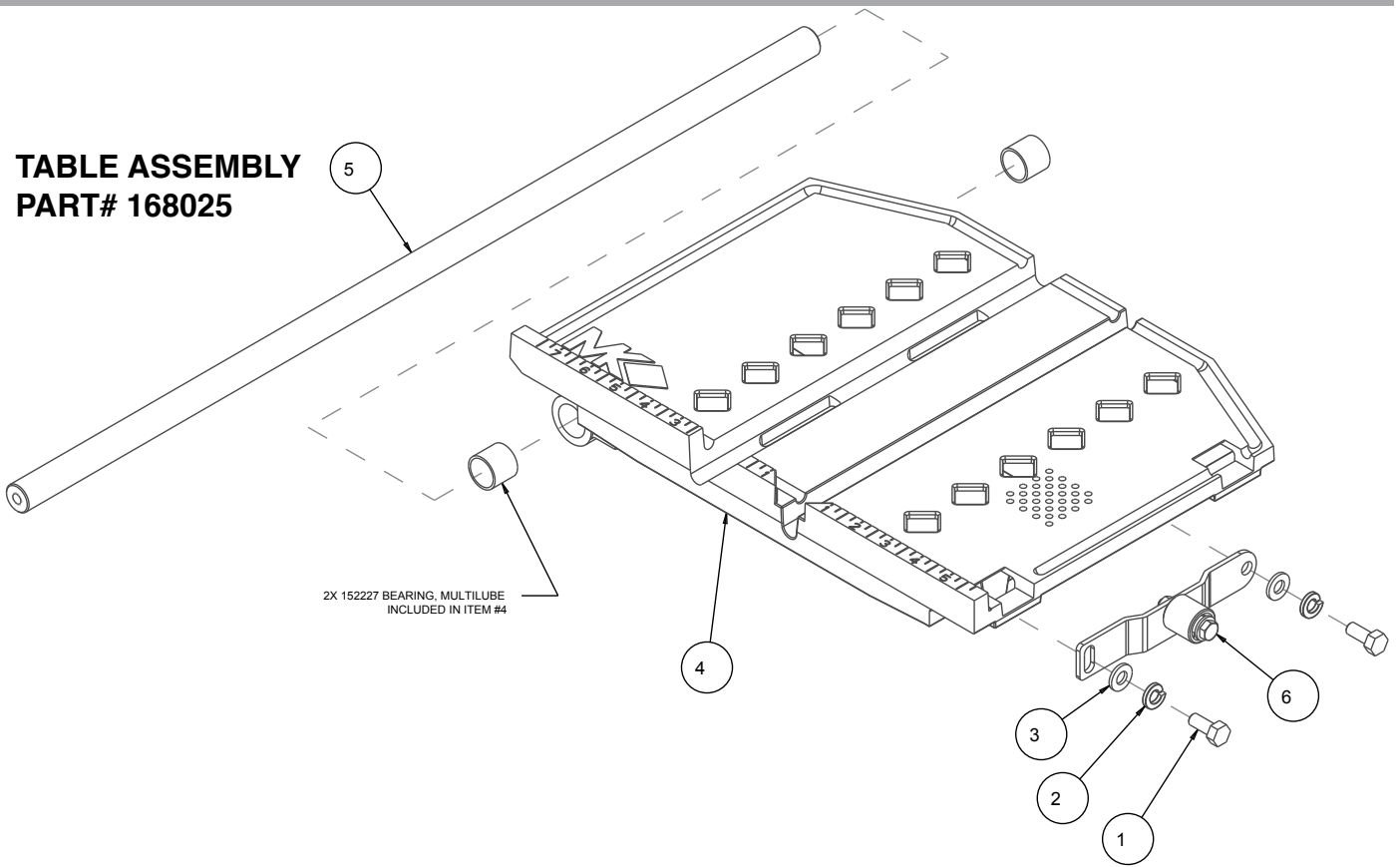

**FRAME ASSEMBLY
PART# 167450**

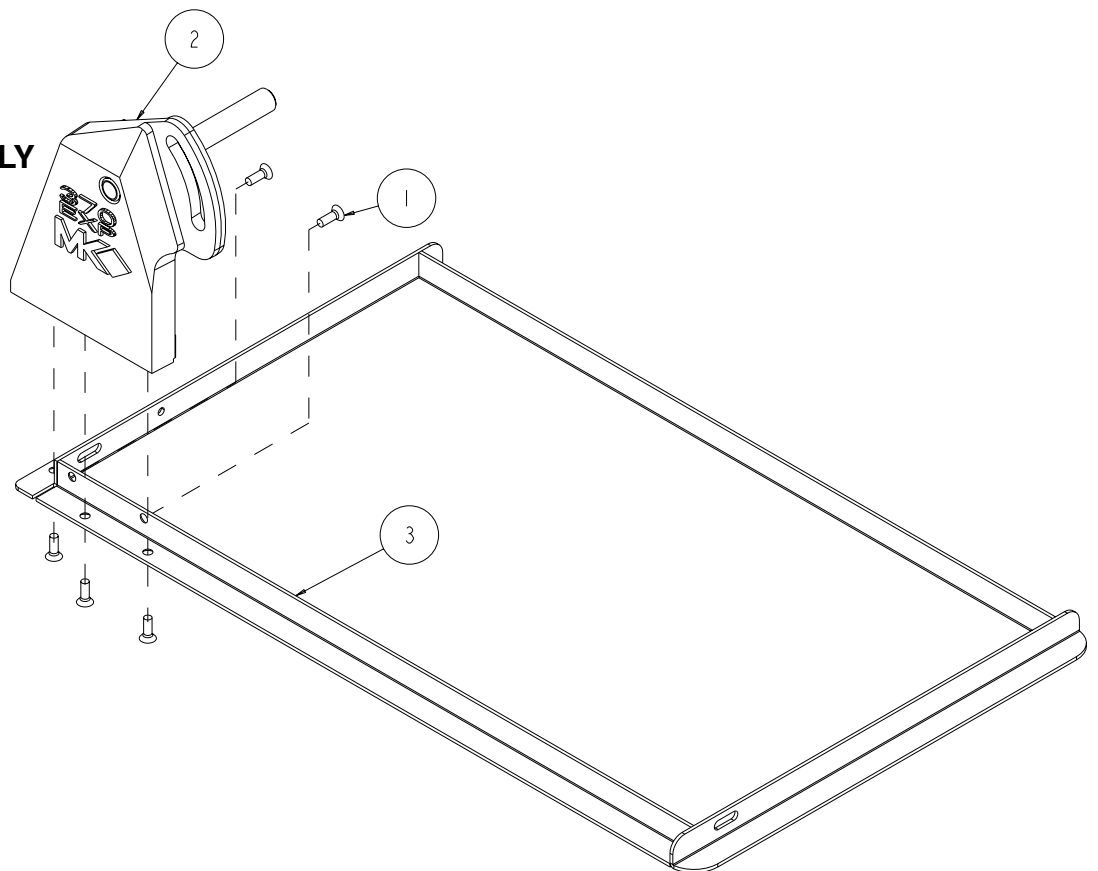

TABLE ASSEMBLY

Item	Description	Part #	Qty
1	SCREW, 5/16-18 X 3/4 HEX HEAD MACHINE	151369	2
2	WASHER, LOCK, SPLIT, 5/16	151747	2
3	WASHER, FLAT, SAE, 5/16	151754	2
4	CASTING, TABLE, 370/770EXP-COMP	159939	1
5	BAR, GUIDE 3/4 DIA	159942	1
6	ASSEMBLY, ROLLER WHEEL	168023	1

FRAME ASSEMBLY

ITEM.	DESCRIPTION	QTY.	PART #
1	SCREW, 1/4 -20 X 3/4 FLAT HEAD PHILLIPS MACHINE	5	154657
2	CASTING, POST MOUNT, COMP	1	167448
3	WELDMENT, FRAME	1	167449

ITEM	NUMBER	DESCRIPTION	
1.	158434	MK-225, 7 x 5/8 Arbor	
2.	139311	MK-215, 7 x 5/8 Arbor	
3.	153293	MK-315, 7 x 5/8 Arbor	
5.	134577-MK	Dual 45° Flat Angle Guide	
6.	134569-MK	90° Protractor	
7.	152792	Dressing Stone	
8.	160488	Side Table	

ORDERING INFORMATION

You may order MK Diamond products through your local MK Diamond distributor or, you may order direct from MK Diamond.

When ordering direct from MK Diamond, please have the following information ready before calling:

- The Model Number of the saw
- The Serial Number of the saw
- Where the saw was purchased and when
- The Part Number for the part(s) being ordered
- The Part Description for the part(s) being ordered

NOTE: There is a \$25.00 minimum order when ordering direct from MK Diamond. A \$6.00 charge will be added to orders having a net billing value under \$50.00. All purchases must be made using VISA, MasterCard or American Express.

All parts may be ordered by calling toll free to – 800 421-5830 or 310 539-5221 and asking for Customer Service. For technical questions, call – 800 474-5594.

RETURN MATERIALS POLICY

To expedite the service relative to the return of a product purchased through MK Diamond, please observe the following:

NOTE: When returning all items, they must have been purchased within the previous twelve (12) months.

- Have the Model Number of the saw
- Have the Serial Number of the saw
- Have the location of where the saw was purchased
- Have the date when the saw was purchased
- Contact Customer Service for approval to return the item(s)
- Obtain a Returned Goods Number (RGA) authorizing the return
- Follow the packaging instructions in the following section
- Ensure your item(s) are prepaid to the destination

For returned items, call toll free to – 800 421-5830 or 310 539-5221 and ask for Customer Service. For technical questions, call – 800 474-5594 or 310 257-2845.

PACKAGING INSTRUCTIONS

- Remove the Cutting Head and Support Angle Assembly
- Dry the saw before shipping
- When packing, include the following: Saw, Diamond Blade, Blade Guard and Support Angle Assembly and Adjustable Cutting Guide (Other Accessories are not required)
- Package the unit in its original container or one of comparable size (do not ship the unit partially exposed)
- Ensure all parts are secured in the packaging to prevent moving

AUTHORIZED SERVICE CENTERS

For quicker repair time, you may contact MK Diamond Customer Service, toll free, at 800 421-5830 or 310 539-5221 for the Authorized Service Center closest to you or visit our web site at www.mkdiamond.com. For technical questions, call – 800 474-5594.

CONTACT:

Please contact MK Diamond Products, Inc. Customer Service Department with any questions you might have regarding distributors, parts or service.

Telephone: **(800) 421-5830**

Fax: **(310) 539-5158**

E-mail: **Customer_Service@MKDiamond.com**

Customer Service Hours: **Monday through Friday, 6AM-4PM PST**

**MK Diamond Products, Inc.
1315 Storm Parkway
Torrance, CA 90501**

MK DIAMOND PRODUCTS, INC. LIMITED WARRANTY

MK DIAMOND PRODUCTS, INC. will guarantee every machine they build, to be free from defects in material and workmanship for (1) one year from date of purchase. The obligation of MK DIAMOND PRODUCTS, INC. under this warranty is limited to the repair or replacement of any parts which, under normal use, prove to be defective in material or workmanship. The parts involved or the unit in question should be returned to MK DIAMOND PRODUCTS, INC. or to a point designated by us, transportation prepaid.

This warranty does not obligate us to bear the cost of labor or transportation charges in connection with replacement or repair of defective parts. Likewise, it shall NOT apply to any unit which has been subjected to misuse, neglect or accident. This warranty does NOT apply to any machine which has been repaired or altered outside our factory.

This warranty does NOT obligate MK DIAMOND PRODUCTS, INC., with respect to items not of our manufacture, such as engines, motors, hydraulics, etc., which are subject to their own guarantees and warranties.

We shall in no event be liable for consequential damages or contingent liabilities arising out of failure of any equipment or parts to operate properly.

© COPYRIGHT 2013, MK DIAMOND PRODUCTS, INC. ALL RIGHTS RESERVED.

The MK Diamond logo is a registered trademark of MK Diamond Products, Inc. and may not be used, reproduced, or altered without written permission. All other trademarks are the property of their respective owners and used with permission.

MK Diamond may have patents, patent applications, trade marks, copyrights of other intellectual property right covering this product in this document.

This manual MUST accompany the equipment at all times. This manual is considered a permanent part of the equipment and should remain with the unit if resold.

The information and specifications included in this publication were in effect at the time of approval for printing.

MK-370EXP TILE SAW
OWNER'S MANUAL, PARTS LIST
& OPERATING INSTRUCTIONS



MK Diamond Products, Inc.

MK Diamond Products, Inc.
1315 Storm Parkway
Torrance, CA 90501

Toll-Free: (800) 421-5830
Phone: (310) 539-5221
Fax: (310) 539-5158
www.mkdiamond.com